

CONTRACT

FURNITURE FOR PROFESSIONALS CATALOGUE

by **mhr**[®]
UPHOLSTERY



CONTRACT

FURNITURE FOR PROFESSIONALS CATALOGUE

by **mhr**[®]
UPHOLSTERY



CONTRACT

by **mhr**[®]
UPHOLSTERY

Esta é a nossa visão através da nossa experiência, orientada para o universo Contract:
Acrescentar conforto e design a espaços que devem ser apelativos, funcionais e resistentes.
Aqui encontra uma seleção de peças que vão ao encontro desta necessidade cada vez mais importante.

*This is our vision through our experience, aimed to the Contract universe:
Adding comfort and design to spaces that must be appealing, functional and resistant.
Here you will find a selection of pieces that meet this increasingly important need.*

Esta es nuestra visión a través de nuestra experiencia, dirigida al universo Contract:
Sumar confort y diseño a espacios que deben ser atractivos, funcionales y resistentes.
Aquí encontrarás una selección de piezas que cubren esta necesidad cada vez más importante.

*C'est notre vision à travers notre expérience, destinée à l'univers Contract :
Apporter confort et design à des espaces qui doivent être esthétiques, fonctionnels et résistants.
Vous trouverez ici une sélection de pièces qui répondent à ce besoin de plus en plus important.*

Sofas & Sleepers



10 | Sleeper M-01



14 | Sleeper M-02



18 | Sleeper M-03



22 | Sleeper M-04



26 | Sleeper M-05

Sommiers & Headboards



50 | Sommier MP-5



51 | Sommier MP-10



52 | Headboard M-101



56 | Headboard M-102



60 | Headboard M-103

Armchairs



82 | M-51



86 | M-52



90 | M-53



94 | M-54



98 | M-55

Pouffs



104 | M-201



106 | M-202



108 | M-203



110 | M-204

Bar Sofas



114 | M-220



118 | M-221



30 | Sleeper M-06



34 | Sleeper M-07



40 | Sleeper M-08



44 | Sofa M-09



64 | Headboard M-104



68 | Headboard M-105



72 | Headboard M-106



76 | Headboard M-107



Sleeper M-01



Sleeper M-02



Sleeper M-03



Sleeper M-04



Sleeper M-05



Sleeper M-06



Sleeper M-07



Sofa/Sleeper M-08



Sofa M-09



Sleeper M-01

Conforto em linhas simples.
Comfort in simple lines.
Comodidad en líneas simples
Confort dans des lignes simples.





Com mecanismo Ref. ID.
 With Ref. ID mechanism.
 Con mecanismo Ref. ID.
 Avec mécanisme Réf. ID.

M-01 SPECIFICATIONS

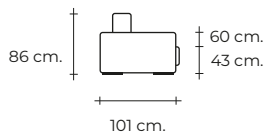

Sofá . Sofa . Sofá . Canapé

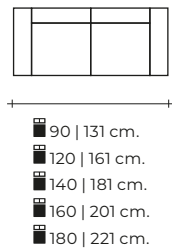

Cama . Bed . Cama . Lit

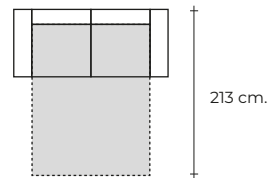

Mecanismo . Mechanism
 Menanismo . Mécanisme

Ref. ID

Colchão . Mattress . Colchón . Matelas

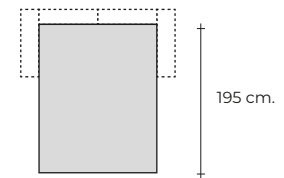

90 | 70 cm.
120 | 100 cm.
140 | 120 cm.
160 | 140 cm.
180 | 160 cm.





Sleeper M-02

A flexibilidade, na maior simplicidade.

Flexibility, in the greatest simplicity.

Flexibilidad, en la mayor sencillez.

La flexibilité, dans la plus grande simplicité.







Com mecanismo Ref. ID.
 With Ref. ID mechanism.
 Con mecanismo Ref. ID.
 Avec mécanisme Réf. ID.

M-02 SPECIFICATIONS

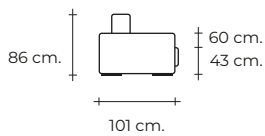

Sofá . Sofa . Sofá . Canapé

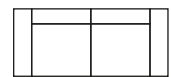

- 90 | 115 cm.
- 120 | 145 cm.
- 140 | 165 cm.
- 160 | 185 cm.
- 180 | 205 cm.

Cama . Bed . Cama . Lit

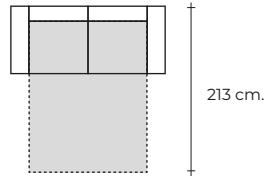

Mecanismo . Mechanism
 Menanismo . Mécanisme

Ref. ID

Colchão . Mattress . Colchón . Matelas

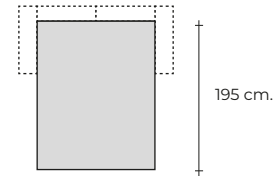

- 90 | 70 cm.
- 120 | 100 cm.
- 140 | 120 cm.
- 160 | 140 cm.
- 180 | 160 cm.



Sleeper M-03

Versátil e elegante. Dimensionado à necessidade.

Versatile and elegant. Sized to need.

Versátil y elegante. Tamaño a la necesidad.

Polyvalent et élégant. Dimensionné au besoin.





Com mecanismo Ref. ID.
 With Ref. ID mechanism.
 Con mecanismo Ref. ID.
 Avec mécanisme Réf. ID.

M-03 SPECIFICATIONS

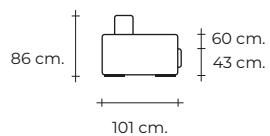

Sofá . Sofa . Sofá . Canapé

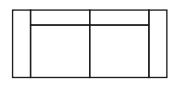

■ 90 | 99 cm.
 ■ 120 | 129 cm.
 ■ 140 | 149 cm.
 ■ 160 | 169 cm.
 ■ 180 | 189 cm.

Cama . Bed . Cama . Lit

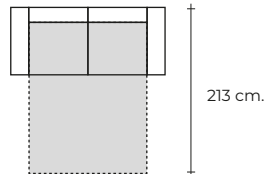

Mecanismo . Mechanism
 Menismo . Mécanisme

Ref. ID

Colchão . Mattress . Colchón . Matelas

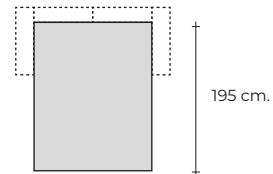

■ 90 | 70 cm.
 ■ 120 | 100 cm.
 ■ 140 | 120 cm.
 ■ 160 | 140 cm.
 ■ 180 | 160 cm.





Sleeper M-04

Conforto e mobilidade orientados às necessidades.

Need-oriented comfort and mobility.

Comodidad y movilidad orientadas a las necesidades.

Confort et mobilité adaptés aux besoins.







Com mecanismo Ref. NIDO.
 With Ref. NIDO mechanism.
 Con mecanismo Ref. NIDO.
 Avec mécanisme Réf. NIDO.

M-04 SPECIFICATIONS

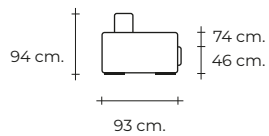

Sofá . Sofa . Sofá . Canapé

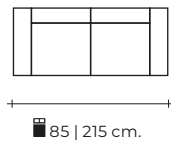

Cama . Bed . Cama . Lit

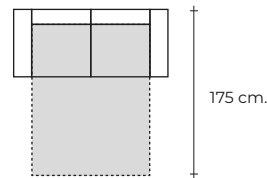

Mecanismo . Mechanism
 Mecanismo . Mécanisme
 Ref. NIDO

Colchão . Mattress . Colchón . Matelas

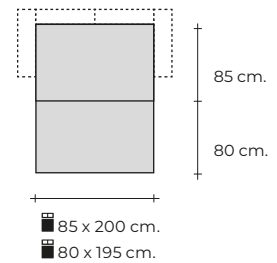



Sleeper M-05

Uma nova forma, um volume diferente.

A new form, a different volume.

Una nueva forma, un volumen diferente.

Une nouvelle forme, un volume différent.





Com mecanismo Ref. ID.
 With Ref. ID mechanism.
 Con mecanismo Ref. ID.
 Avec mécanisme Réf. ID.

M-05 SPECIFICATIONS

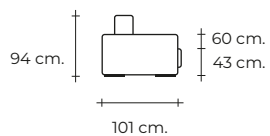

Sofá . Sofa . Sofá . Canapé

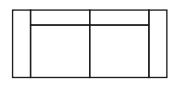

■ 90 | 130 cm.
 ■ 120 | 160 cm.
 ■ 140 | 180 cm.
 ■ 160 | 200 cm.
 ■ 180 | 220 cm.

Cama . Bed . Cama . Lit

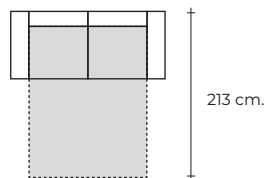

Mecanismo . Mechanism
 Menismo . Mécanisme

Ref. ID

Colchão . Mattress . Colchón . Matelas

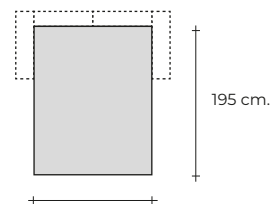

■ 90 | 70 cm.
 ■ 120 | 100 cm.
 ■ 140 | 120 cm.
 ■ 160 | 140 cm.
 ■ 180 | 160 cm.





Sleeper M-06

Elegância e conforto elevados ao expoente máximo.

Elegance and comfort elevated to the maximum exponent.

Elegancia y confort elevados al máximo exponente.

Élégance et confort élevés au maximum.







Com mecanismo Ref. ID.
 With Ref. ID mechanism.
 Con mecanismo Ref. ID.
 Avec mécanisme Réf. ID.

M-06 SPECIFICATIONS

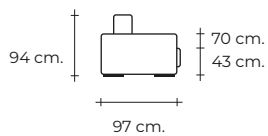

Sofá . Sofa . Sofá . Canapé



- 90 | 105 cm.
- 120 | 135 cm.
- 140 | 155 cm.
- 160 | 175 cm.
- 180 | 195 cm.

Cama . Bed . Cama . Lit

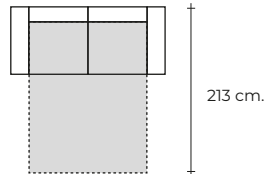

Mecanismo . Mechanism
 Menanismo . Mécanisme

Ref. ID

Colchão . Mattress . Colchón . Matelas

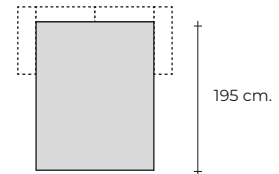

- 90 | 70 cm.
- 120 | 100 cm.
- 140 | 120 cm.
- 160 | 140 cm.
- 180 | 160 cm.



Sleeper M-07

Simplicidade e elegância de linhas rectas.

Simplicity and elegance of straight lines.

Sencillez y elegancia de líneas rectas.

Simplicité et élégance des lignes droites.





Versatilidade como forma de expressão.

Versatility as a form of expression.

La versatilidad como forma de expresión.

La polyvalence comme forme d'expression.





Com mecanismo Ref. ID.
 With Ref. ID mechanism.
 Con mecanismo Ref. ID.
 Avec mécanisme Réf. ID.

M-07 SPECIFICATIONS

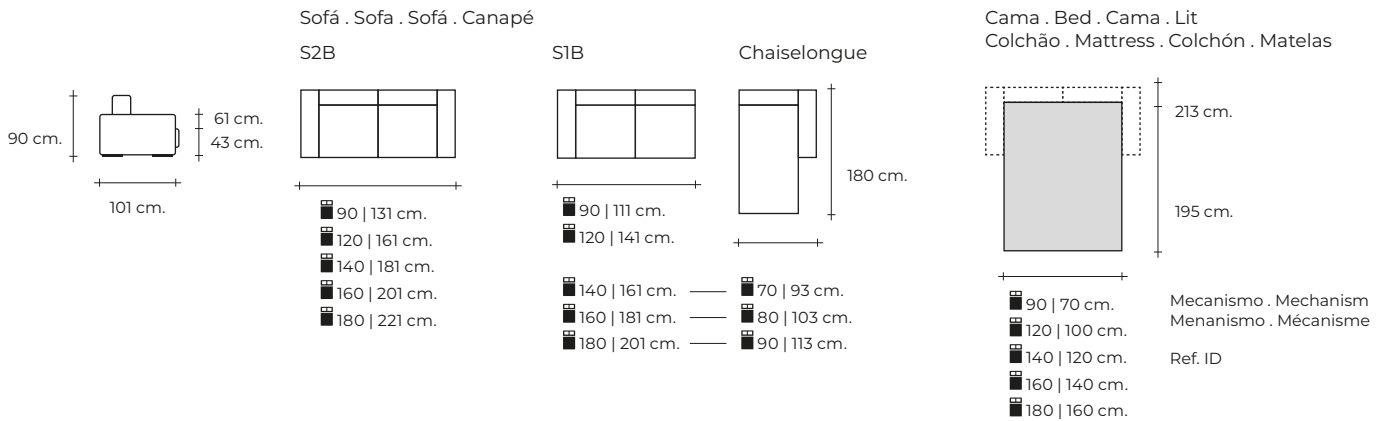





Sofa/Sleeper M-08

Intemporal, contemporâneo, funcional.

Timeless, contemporary, functional.

Atemporal, contemporâneo, funcional.

Intemporel, contemporain, fonctionnel.







Com mecanismo Ref. 2D.
 With Ref. 2D mechanism.
 Con mecanismo Ref. 2D.
 Avec mécanisme Réf. 2D.

M-08 SPECIFICATIONS

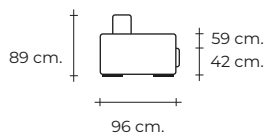

Sofá . Sofa . Sofá . Canapé

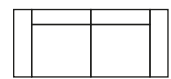

2 ↓ 180 cm.
 3 ↓ 200 cm.

■ 133 | 180 cm.
 ■ 153 | 200 cm.

Cama . Bed . Cama . Lit

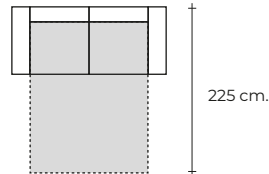

Mecanismo . Mechanism
 Menanismo . Mécanisme

Ref. 2D

Colchão . Mattress . Colchón . Matelas

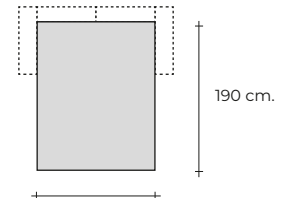

■ 133 | 113 cm.
 ■ 153 | 133 cm.

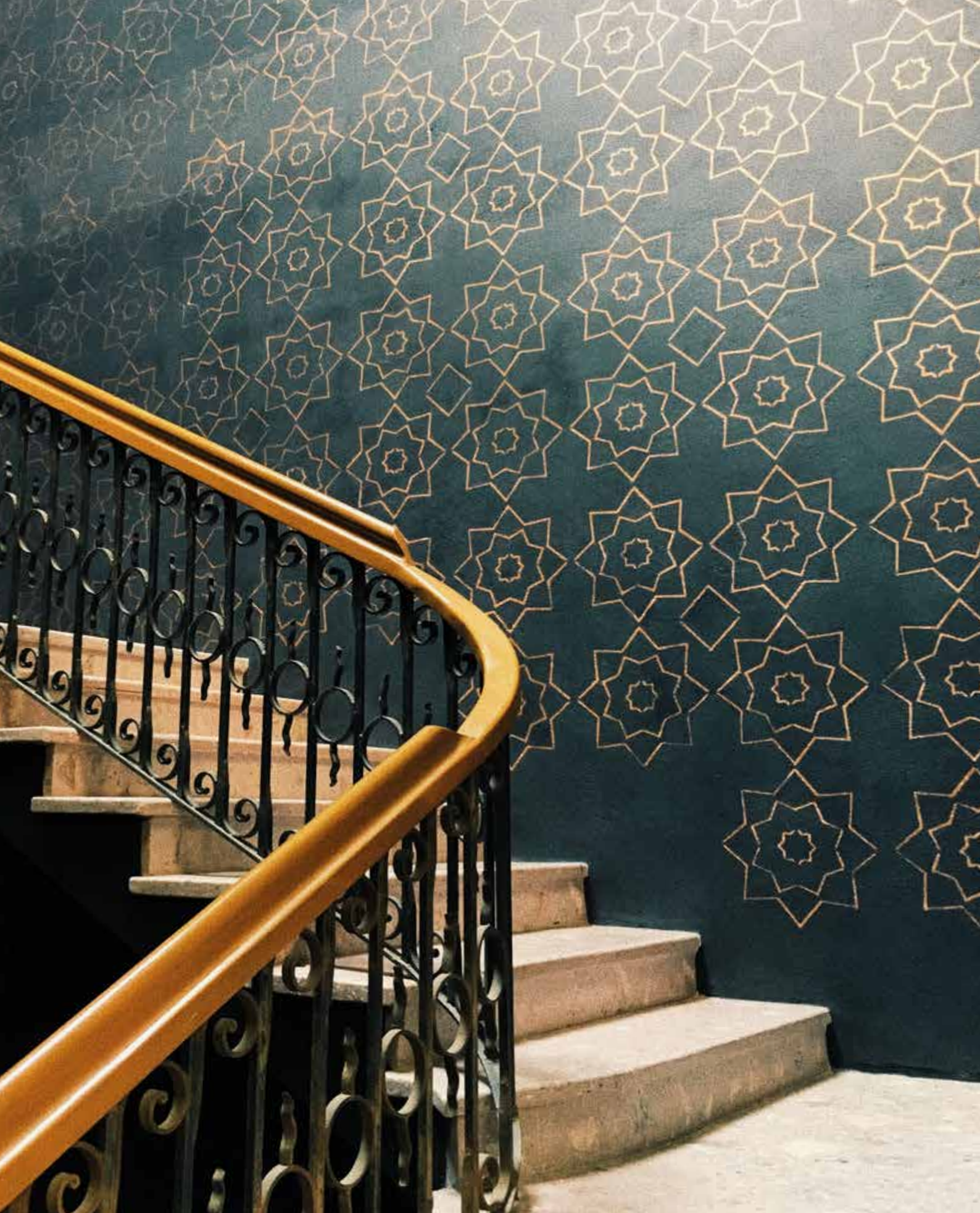

Sofa M-09

Reinterpretação moderna de um clássico.
A modern reinterpretation of a classic.
Reinterpretación moderna de un clásico.
Réinterprétation moderne d'un classique.





M-09 SPECIFICATIONS

Sofá . Sofa . Sofá . Canapé

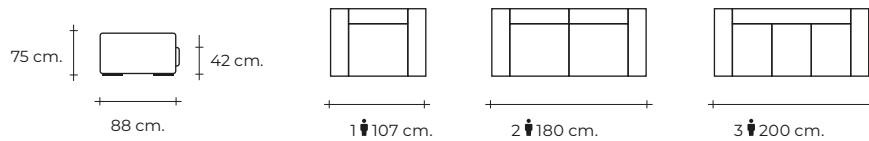





Sommier MP-5



Sommier MP-10



Headboard M-101



Headboard M-102



Headboard M-103



Headboard M-104



Headboard M-105



Headboard M-106



Headboard M-107

Sommiers & Headboards

Diversas combinações possíveis. Desde a base à cabeceira, tudo pode ser conjugado de acordo com a dinâmica do espaço.

Several possible combinations. From the base to the headboard, everything can be combined according to the dynamics of the space.

Varias combinaciones posibles. Desde la base hasta el cabecero, todo se puede combinar según la dinámica del espacio.

Plusieurs combinaisons possibles. Du sommier à la tête de lit, tout peut être combiné selon la dynamique de l'espace.

Sommier MP-5

Elegante, prática, versátil e de pé baixo.
Elegant, practical, versatile and low standing.
 Elegantes, prácticas, versátiles y de pie bajo.
Elégant, pratique, polyvalent et bas.



MP-05 SPECIFICATIONS

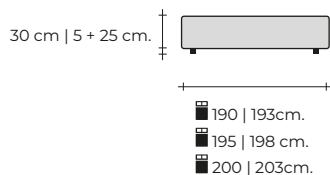

Sommier . Sommier . Somier . Sommier

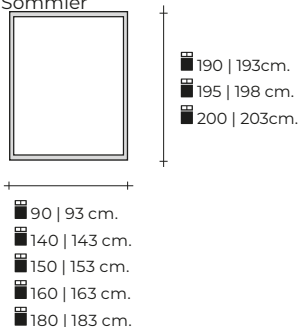

Colchão . Mattress . Colchón . Matelas

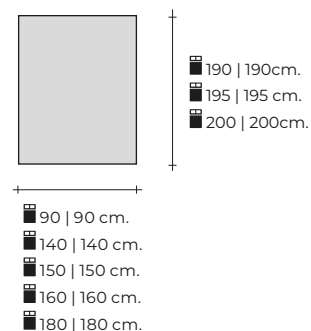

Sommier MP-10

A mesma visão anterior, mas desta feita, com o pé alto.

Same view as before, but this time with the foot high.

La misma vista que antes, pero esta vez, con el pie en alto.

La même vue que précédemment, mais cette fois-ci, avec le pied haut.



MP-10 SPECIFICATIONS

30 cm | 10 + 20 cm.



■ 190 | 193cm.
■ 195 | 198 cm.
■ 200 | 203cm.

Sommier . Sommier . Somier .
Sommier

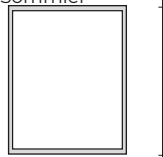

■ 90 | 93 cm.
■ 140 | 143 cm.
■ 150 | 153 cm.
■ 160 | 163 cm.
■ 180 | 183 cm.

■ 190 | 193cm.
■ 195 | 198 cm.
■ 200 | 203cm.

Colchão . Mattress . Colchón . Matelas

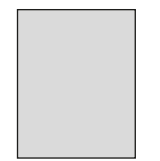

■ 90 | 90 cm.
■ 140 | 140 cm.
■ 150 | 150 cm.
■ 160 | 160 cm.
■ 180 | 180 cm.

■ 190 | 190cm.
■ 195 | 195 cm.
■ 200 | 200cm.



Headboard M-101

Quando o caminho certo, é a maneira mais simples.

When the right path, is the simplest way.

Cuando el camino correcto, es la forma más sencilla.

Lorsque le bon chemin, est le moyen le plus simple.





Fig.1



Fig.2

Fig.1 - Com Sommier MP-05. *With MP-05 Sommier. Con Sommier MP-05. Avec sommier MP-05.*

Fig.2 - Com Sommier MP-10. *With MP-10 Sommier. Con Sommier MP-10. Avec sommier MP-10.*

M-101 SPECIFICATIONS

Cabeceira . Headboard . Cabecero . Tête de Lit.

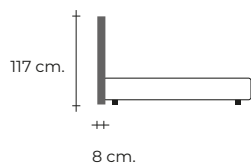

■ 90 | 93 cm.
 ■ 140 | 143 cm.
 ■ 150 | 153 cm.
 ■ 160 | 163 cm.
 ■ 180 | 183 cm.

Colchão . Mattress . Colchón . Matelas



■ 190 | 190cm.
 ■ 195 | 195 cm.
 ■ 200 | 200cm.

■ 90 | 90 cm.
 ■ 140 | 140 cm.
 ■ 150 | 150 cm.
 ■ 160 | 160 cm.
 ■ 180 | 180 cm.



M-101



Headboard M-102

Por vezes necessitamos apenas de um detalhe.

Sometimes we just need a little detail.

A veces solo necesitamos un pequeño detalle.

Parfois, nous avons juste besoin d'un petit détail.







Fig.1



Fig.2

Fig.1 - Com Sommier MP-05. *With MP-05 Sommier. Con Sommier MP-05. Avec sommier MP-05.*

Fig.2 - Com Sommier MP-10. *With MP-10 Sommier. Con Sommier MP-10. Avec sommier MP-10.*

M-102 SPECIFICATIONS

Cabeceira . Headboard . Cabecero . Tête de Lit.

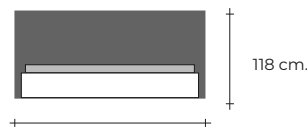
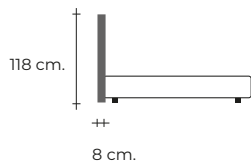

- 90 | 93 cm.
- 140 | 143 cm.
- 150 | 153 cm.
- 160 | 163 cm.
- 180 | 183 cm.

Colchão . Mattress . Colchón . Matelas

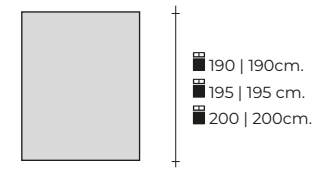

- 90 | 90 cm.
- 140 | 140 cm.
- 150 | 150 cm.
- 160 | 160 cm.
- 180 | 180 cm.



Headboard M-103

O quebrar do horizonte, sob a forma de uma linha curva.

The breaking of the horizon, in the form of a curved line.

La ruptura del horizonte, en forma de línea curva.

La rupture de l'horizon, sous la forme d'une ligne courbe.





Fig.1



Fig.2

Fig.1 - Com Sommier MP-05. *With MP-05 Sommier. Con Sommier MP-05. Avec sommier MP-05.*

Fig.2 - Com Sommier MP-10. *With MP-10 Sommier. Con Sommier MP-10. Avec sommier MP-10.*

M-103 SPECIFICATIONS

Cabeceira . Headboard . Cabecero . Tête de Lit.

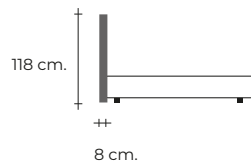

■ 90 | 93 cm.
 ■ 140 | 143 cm.
 ■ 150 | 153 cm.
 ■ 160 | 163 cm.
 ■ 180 | 183 cm.

Colchão . Mattress . Colchón . Matelas



■ 190 | 190cm.
 ■ 195 | 195 cm.
 ■ 200 | 200cm.

■ 90 | 90 cm.
 ■ 140 | 140 cm.
 ■ 150 | 150 cm.
 ■ 160 | 160 cm.
 ■ 180 | 180 cm.



M-103



Demand

Standard or
Deluxe Room
Standard or
Deluxe Room

The hotel is committed to providing the highest quality service and amenities to our guests. We are proud to offer a variety of room types and services to meet your needs. For more information, please contact our front desk.

BOXED WATER IS BETTER.

REUSE YOUR TOWEL.
TURN OFF THE LIGHTS.
DRINK BOXED WATER.

In addition to providing the highest quality service and amenities, we are committed to providing the highest quality water to our guests. Boxed Water is the best way to stay hydrated.

BOXED WATER IS BETTER.

PURIFIED WATER
(100% BOTTLED WATER)

Headboard M-104

Simples, elegante, talvez até diferente.

Simple, elegant, maybe even different.

Simple, elegante, tal vez incluso diferente.

Simple, élégant, peut-être même différent.







Fig.1



Fig.2

Fig.1 - Com Sommier MP-05. *With MP-05 Sommier. Con Sommier MP-05. Avec sommier MP-05.*

Fig.2 - Com Sommier MP-10. *With MP-10 Sommier. Con Sommier MP-10. Avec sommier MP-10.*

M-104-SPECIFICATIONS

Cabeceira . Headboard . Cabecero . Tête de Lit.

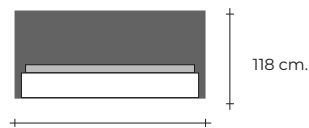
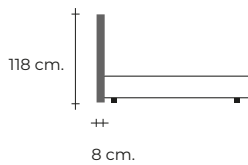

- 90 | 93 cm.
- 140 | 143 cm.
- 150 | 153 cm.
- 160 | 163 cm.
- 180 | 183 cm.

Colchão . Mattress . Colchón . Matelas

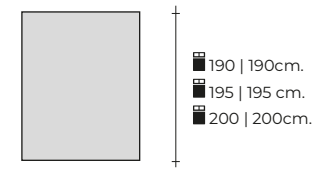

- 90 | 90 cm.
- 140 | 140 cm.
- 150 | 150 cm.
- 160 | 160 cm.
- 180 | 180 cm.



Headboard M-105

O evocar da verticalidade das nossas ideias.
Evoking the verticality of our ideas.
Evocando la verticalidad de nuestras ideas.
Evoquer la verticalité de nos idées.





Fig.1

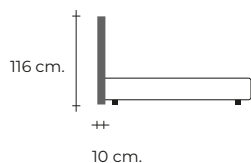

Fig.2

Fig.1 - Com Sommier MP-05. *With MP-05 Sommier. Con Sommier MP-05. Avec sommier MP-05.*

Fig.2 - Com Sommier MP-10. *With MP-10 Sommier. Con Sommier MP-10. Avec sommier MP-10.*

M-105 SPECIFICATIONS



Cabeceira . Headboard . Cabecero . Tête de Lit.

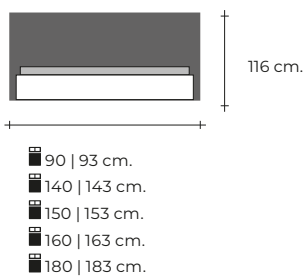

Colchão . Mattress . Colchón . Matelas

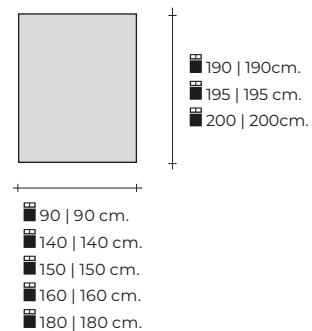





Headboard M-106

Um olhar sobre o passado, que se alia à modernidade.

A look at the past, which is allied to modernity.

Una mirada al pasado, que se alía con la modernidad.

Un regard sur le passé, qui s'allie à la modernité.







Fig.1

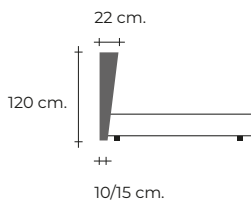

Fig.2

Fig.1 - Com Sommier MP-05. *With MP-05 Sommier. Con Sommier MP-05. Avec sommier MP-05.*

Fig.2 - Com Sommier MP-10. *With MP-10 Sommier. Con Sommier MP-10. Avec sommier MP-10.*

M-106 SPECIFICATIONS



Cabeceira . Headboard . Cabecero . Tête de Lit.

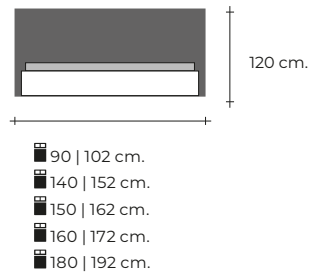

Colchão . Mattress . Colchón . Matelas

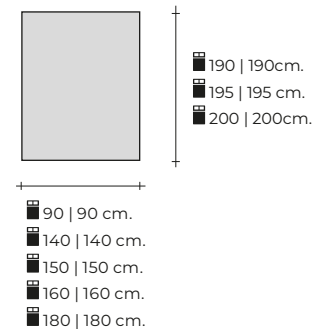



Headboard M-107

O sentimento acolhedor que encontramos na simplicidade.

The cozy feeling we find in simplicity.

La sensación acogedora la encontramos en la sencillez.

La sensation de confort que l'on retrouve dans la simplicité.





Fig.1

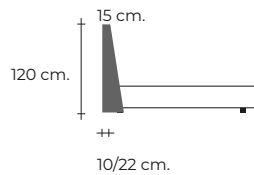

Fig.2

Fig.1 - Com Sommier MP-05. *With MP-05 Sommier. Con Sommier MP-05. Avec sommier MP-05.*

Fig.2 - Com Sommier MP-10. *With MP-10 Sommier. Con Sommier MP-10. Avec sommier MP-10.*

M-107 SPECIFICATIONS



Cabeceira . Headboard . Cabecero . Tête de Lit.

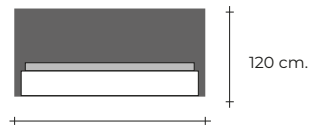

■ 90 | 102 cm.
■ 140 | 152 cm.
■ 150 | 162 cm.
■ 160 | 172 cm.
■ 180 | 192 cm.

Colchão . Mattress . Colchón . Matelas

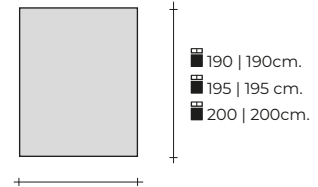

■ 90 | 90 cm.
■ 140 | 140 cm.
■ 150 | 150 cm.
■ 160 | 160 cm.
■ 180 | 180 cm.





M-51



M-52



M-53



M-54



M-55



M-51

A inspiração, traz-nos uma mistura de linhas.

Inspiration brings us a mixture of lines.

La inspiración nos trae una mezcla de líneas.

L'inspiration nous apporte un mélange de lignes.





Tudo se resume ao conforto. E as espumas de alta densidade ajudam a atingir esse objetivo.

It all comes down to comfort. And high-density foams help achieve that goal.

Todo se reduce a la comodidad. Y las espumas de alta densidad ayudan a lograr ese objetivo.

Tout est question de confort. Et les mousses à haute densité aident à atteindre cet objectif.

M-51 SPECIFICATIONS

Cadeiraão . Armchair . Sillón .
Fauteuil

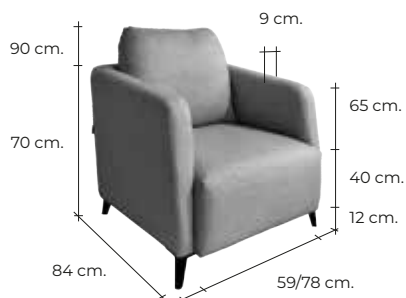





M-52

Conforto, com uma pitada de pormenor.

Comfort, with a hint of detail.

Comodidad, con un toque de detalle.

Confort, avec un soupçon de détail.





Espumas de alta densidade proporcionam um excelente grau de conforto.

High density foams provide an excellent degree of comfort.

Las espumas de alta densidad proporcionan un excelente grado de comodidad.

Les mousses à haute densité offrent un excellent degré de confort.

M-52 SPECIFICATIONS

1 🪑 Sofá . Sofa . Sofá . Canapé



2 🪑 Sofá . Sofa . Sofá . Canapé





3 Sofá . Sofa . Sofá . Canapé





M-53

Linhas curvas, arredondadas, com uma certa nostalgia.

Curved lines, rounded, with a certain nostalgia.

Líneas curvas, redondeadas, con cierta nostalgia.

Des lignes courbes, arrondies, avec une certaine nostalgie.





—
 Tudo se resume ao conforto. E as espumas de alta densidade ajudam a atingir esse objetivo.

It all comes down to comfort. And high-density foams help achieve that goal.

Todo se reduce a la comodidad. Y las espumas de alta densidad ayudan a lograr ese objetivo.

Tout est question de confort. Et les mousses à haute densité aident à atteindre cet objectif.

—

M-53 SPECIFICATIONS

1  Sofá . Sofa . Sofá . Canapé



2  Sofá . Sofa . Sofá . Canapé

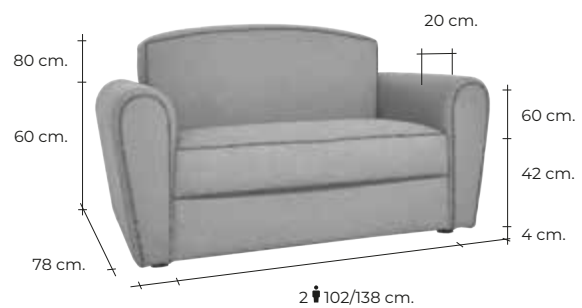



3 Sofá . Sofa . Sofá . Canapé





M-54

Acolhedor, singelo, ideal para aquele momento de pausa.

Cozy, simple, ideal for that moment of pause.

Acogedor, sencillo, ideal para ese momento de pausa.

Comfortable, simple, idéal pour ce moment de pause.





Espumas de alta densidade proporcionam um excelente grau de conforto.

High density foams provide an excellent degree of comfort.

Las espumas de alta densidad proporcionan un excelente grado de comodidad.

Les mousses à haute densité offrent un excellent degré de confort.

M-54 SPECIFICATIONS

Cadeiraão . Armchair . Sillón .
Fauteuil







M-55

Um olhar diferente, uma inspiração de outras formas.

A different look, an inspiration in other ways.

Una mirada diferente, una inspiración en otros sentidos.

Un regard différent, une inspiration d'autres manières.





Tudo se resume ao conforto. E as espumas de alta densidade ajudam a atingir esse objetivo.

It all comes down to comfort. And high-density foams help achieve that goal.

Todo se reduce a la comodidad. Y las espumas de alta densidad ayudan a lograr ese objetivo.

Tout est question de confort. Et les mousses à haute densité aident à atteindre cet objectif.

M-55 SPECIFICATIONS

Cadeiraão . Armchair . Sillón .
Fauteuil

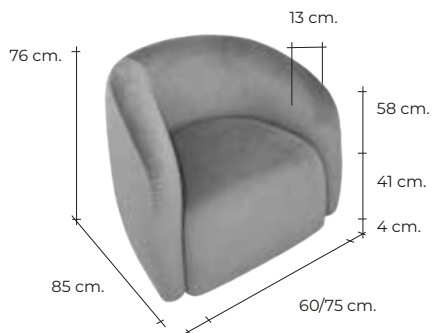





M-201



M-202



M-203



M-204



M-201 SPECIFICATIONS

Pufe . Pouff . Puf . Pouf

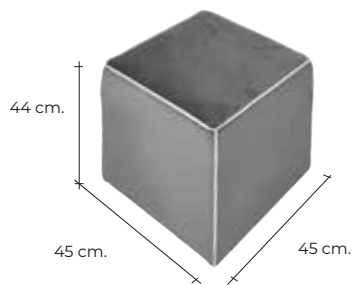

M-201

A união das formas retas, adocicadas com um detalhe informal.
The union of straight shapes, sweetened with an informal detail.
La unión de formas rectas, endulzada con un detalle informal.
L'union de formes droites, adoucie par un détail informel.





M-201 SPECIFICATIONS

Pufe . Pouff . Puf . Pouf

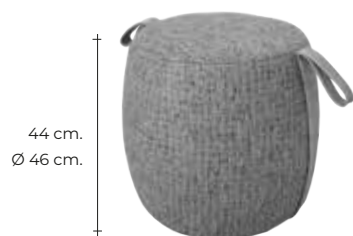

M-202

Estética que se funde com o sentido prático.
Aesthetics that merges with the practical sense.
Estética que se funde con el sentido práctico.
Esthétique qui se confond avec le sens pratique.





M-203 SPECIFICATIONS

Pufe . Pouff . Puf . Pouf

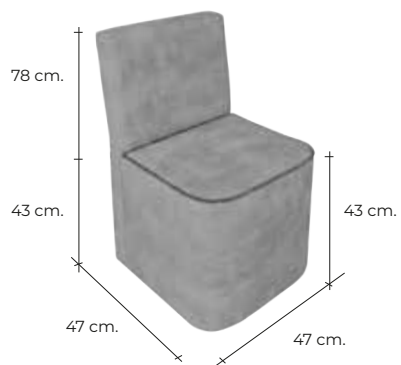

M-203

Da mistura de linhas e pormenores, surgem por vezes as nossas ideias mais práticas.

From the mixture of lines and details, our most practical ideas sometimes emerge.

De la mezcla de líneas y detalles, a veces surgen nuestras ideas más prácticas.

Du mélange des lignes et des détails, émergent parfois nos idées les plus pratiques.





M-204 SPECIFICATIONS

Pufe . Pouff . Puf . Pouf

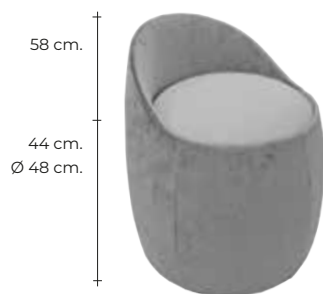

M-204

Linhas curvas, elegantes, evocando a montanha nos nossos sentimentos.

Curved, elegant lines, evoking the mountain in our feelings.

Líneas curvas y elegantes, evocando la montaña en nuestros sentimientos.

Lignes courbes et élégantes, évoquant la montagne dans nos sentiments.





M-220



M-221

Bar Sofas

Para um momento de pausa ou de reflexão, versatilidade modular e elegância, a nossa visão para um espaço multifacetado.

For a moment of pause or reflection, modular versatility and elegance, our vision for a multifaceted space.

Para un momento de pausa o reflexión, versatilidad modular y elegancia, nuestra visión de un espacio multifacético.

Pour un moment de pause ou de réflexion, versatilité modulable et élégance, notre vision d'un espace aux multiples facettes.



M-220

Um olhar simples e elegante, sob um momento descontraído.

A simple and elegant look, under a relaxed moment.

Un look sencillo y elegante, bajo un momento relajado.

Un look simple et élégant, sous un moment décontracté.





Conforto com as espumas de alta densidade. Versatilidade com o sistema modular.

Comfort with high density foams. Versatility with the modular system.

Conforto with high density foams. Versatility with the modular system.

Confort avec mousses haute densité. Polyvalence avec le système modulaire.

M-220 SPECIFICATIONS

Sofá s/ Braços . n/ Arms Sofa . Sofá s/ Brazos . Canapé s/ Bras



Canto . Corner . Esquina . Angle





M-220



M-221

Elegância sob a forma de linhas verticais.

Elegance in the form of vertical lines..

Elegancia en forma de líneas verticales.

Élégance sous forme de lignes verticales.





Conforto com as espumas de alta densidade. Versatilidade com o sistema modular.

Comfort with high density foams.

Versatility with the modular system.

Conforto com high density foams.

Versatility with the modular system.

Confort avec mousses haute

densité. Polyvalence avec le système modulaire.

M-221 SPECIFICATIONS

Sofá s/ Braços . n/ Arms Sofa . Sofá s/ Brazos . Canapé s/ Bras

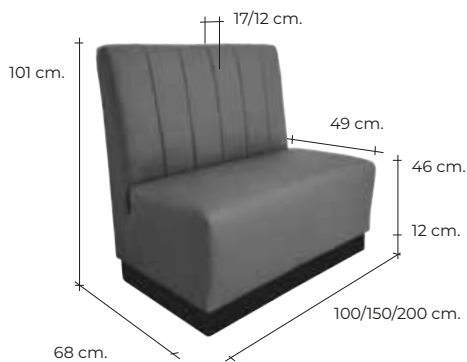

Canto . Corner . Esquina . Angle

