



K



**ACESSÓRIOS PARA
CASA DE BANHO /
BATHROOM
ACCESSORIES /
ACCESORIOS
DE BAÑO.**

INDICE / INDEX

ACESSÓRIOS PARA CASA DE BANHO /
 BATHROOM ACCESSORIES /
 ACCESORIOS DE BAÑO.



STOUT WC SERIES

1022



BRANCH SERIES

1028



SLIM BLACK TO WHITE SERIES

1034



WHITE Q SERIES

1040



WHITE SERIES

1043



WENGÉ SERIES

1046



2D SERIES

1050



TONDA SERIES

1054

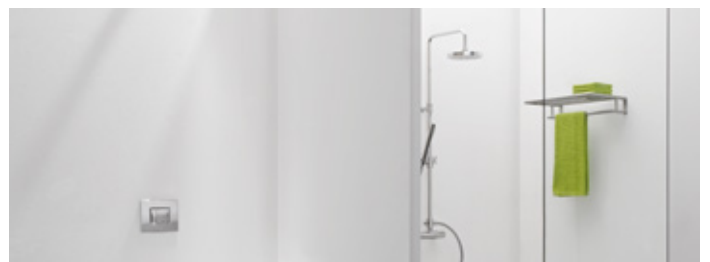

ÂNGULO SERIES

1060



FINE SERIES

1068



MERIDIAN SERIES

1078



SUBTIL SERIES

1082



QUADRO SERIES

1086

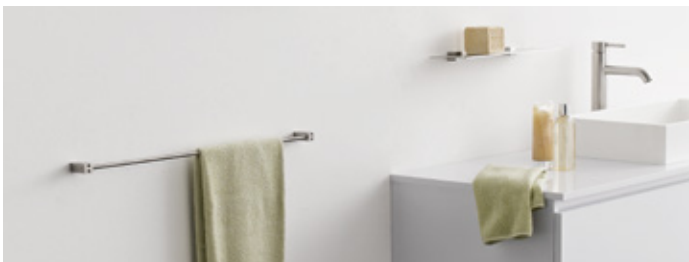

QUADRATO SERIES

1091



CILINDRO SERIES

1094

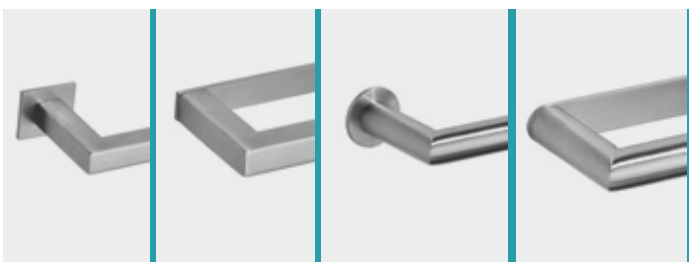

ACESSÓRIOS

1096



INDUSTRIAL SERIES

1097



AUXÍLIOS PARA PESSOAS COM MOBILIDADE CONDICIONADA

1114



BIN SERIES

1124

K/1022



Accesórios para casa de banho /
Bathroom accessories /
Accesorios de baño.

Stout
WC

WWW.JNF.PT

STOUT WC SERIES

ACESSÓRIOS PARA CASA DE BANHO /
BATHROOM ACCESSORIES /
ACCESORIOS DE BAÑO.





STOUT WC SERIES

ACESSÓRIOS PARA CASA DE BANHO /
 BATHROOM ACCESSORIES /
 ACCESORIOS DE BAÑO.

NEW

IN.53.200.____
IN.53.200.____.P

Toalheiro / Towel holder / Toallero.

Design: Christian Magalhães



.P

.TB

.TG

.TCO

.TCH

MATERIAL: EN 1.4301 / AISI 304

ACABAMENTO / FINISH / ACABADO:

IN.53.200: SATINADO / SATIN / SATIN

IN.53.200.P: POLIDO / POLISHED / PULIDO

OPTIONAL: PVD TITANIUM COATED

.TB / .TG / .TCO / .TCH

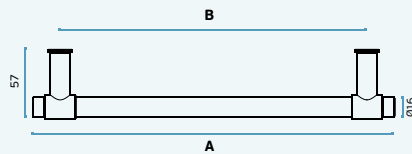

REF	A	B
IN.53.200.250	250mm	269mm
IN.53.200.425	425mm	444mm
IN.53.200.600	600mm	619mm

.P
Mirror
finish.TB
PVD
Titanium
black.TG
PVD
Titanium
gold.TCO
PVD
Titanium
copper.TCH
PVD
Titanium
chocolate

NEW

IN.14.125
IN.14.125.P

Cabide de parede triplo /

Triple wall hook /

Percha triple.

Design: Christian Magalhães



.P

.TB

.TG

.TCO

.TCH

MATERIAL: EN 1.4301 / AISI 304

ACABAMENTO / FINISH / ACABADO:

IN.14.125: SATINADO / SATIN / SATIN

IN.14.125.P: POLIDO / POLISHED / PULIDO

OPTIONAL: PVD TITANIUM COATED

.TB / .TG / .TCO / .TCH

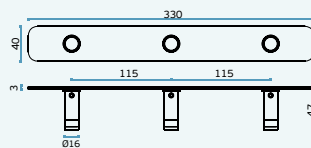

NEW

IN.14.123
IN.14.123.P

Cabide de parede

Wall hook / Percha.



.P

.TB

.TG

.TCO

.TCH

EN 1.4301 / AISI 304

STANDARD FINISH:

SATINADO / SATIN / SATIN

POLIDO / POLISHED / PULIDO

OPTIONAL: PVD TITANIUM

.TB / .TG / .TCO / .TCH

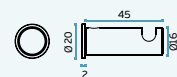

NEW

IN.14.126
IN.14.126.P

Cabide de parede duplo /

Double wall hook /

Percha doble.



.P

.TB

.TG

.TCO

.TCH

MATERIAL: EN 1.4301 / AISI 304

ACABAMENTO / FINISH / ACABADO:

IN.14.126: SATINADO / SATIN / SATIN

IN.14.126.P: POLIDO / POLISHED / PULIDO

OPTIONAL: PVD TITANIUM COATED

.TB / .TG / .TCO / .TCH

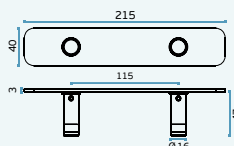

NEW

IN.14.124
IN.14.124.P

Cabide de parede duplo

Double wall hook /

Percha doble.



.P

.TB

.TG

.TCO

.TCH

EN 1.4301 / AISI 304

STANDARD FINISH:

SATINADO / SATIN / SATIN

POLIDO / POLISHED / PULIDO

OPTIONAL: PVD TITANIUM

.TB / .TG / .TCO / .TCH

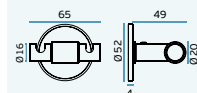



STOUT WC SERIES

ACESSÓRIOS PARA CASA DE BANHO /
 BATHROOM ACCESSORIES /
 ACCESORIOS DE BAÑO.

NEW

IN.53.201 IN.53.201.P

Porta rolos /
 Paper holder /
 Soporte de papel.



MATERIAL: EN 1.4301 / AISI 304

ACABAMENTO / FINISH / ACABADO:
IN.53.201: SATINADO / SATIN / SATIN
IN.53.201.P: POLIDO / POLISHED / PULIDO

OPTIONAL: PVD TITANIUM COATED

.TB / .TG / .TCO / .TCH

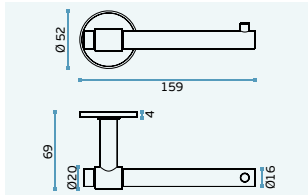

NEW

IN.53.202 IN.53.202.P

Porta rolos vertical /
 Vertical paper holder /
 Soporte de papel vertical.

MATERIAL: EN 1.4301 / AISI 304

ACABAMENTO / FINISH / ACABADO:
IN.53.202: SATINADO / SATIN / SATIN
IN.53.202.P: POLIDO / POLISHED / PULIDO

OPTIONAL: PVD TITANIUM COATED

.TB / .TG / .TCO / .TCH

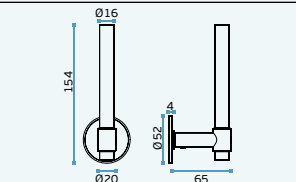

.P
Mirror
finish

.TB
PVD
Titanium
black

.TG
PVD
Titanium
gold

.TCO
PVD
Titanium
copper

.TCH
PVD
Titanium
chocolate

IN.42.165.P

IN.42.165.PP
 Porta piaçaba de parede /
 Wall toilet brush /
 Escobillero de pared



MATERIAL:
IN.42.165.P.304 - EN 1.4301 / AISI 304
IN.42.165.P.316 - EN 1.4401 / AISI 316

ACABAMENTO / FINISH / ACABADO:
STANDARD: SATINADO / SATIN / SATIN

MATERIAL:
IN.42.165.PP.304 - EN 1.4301 / AISI 304
IN.42.165.PP.316 - EN 1.4401 / AISI 316

ACABAMENTO / FINISH / ACABADO:
 POLIDO / POLISHED / PULIDO

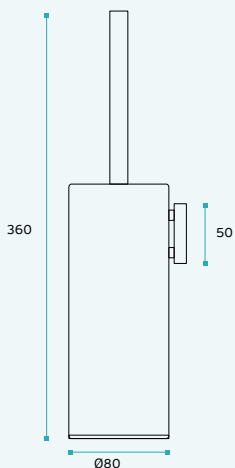

IN.42.164

IN.42.164.P
 Porta piaçaba /
 Toilet brush /
 Escobillero



MATERIAL:
IN.42.164.304 - EN 1.4301 / AISI 304
IN.42.164.316 - EN 1.4401 / AISI 316

ACABAMENTO / FINISH / ACABADO:
STANDARD: SATINADO / SATIN / SATIN

MATERIAL:
IN.42.164.P.304 - EN 1.4301 / AISI 304
IN.42.164.P.316 - EN 1.4401 / AISI 316

ACABAMENTO / FINISH / ACABADO:
 POLIDO / POLISHED / PULIDO

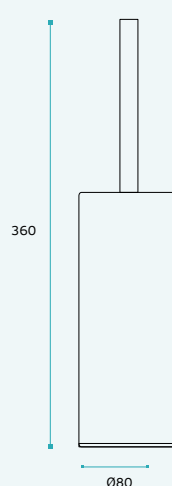

.P
Mirror
finish

.TB
PVD
Titanium
black

.TG
PVD
Titanium
gold

.TCO
PVD
Titanium
copper

.TCH
PVD
Titanium
chocolate



IN.53.200.P
Toalheiro / Towel holder / Toallero.
(EN 1.4301 / AISI 304)



IN.14.125.P
Cabide /
Hook / Percha.
(EN 1.4301 / AISI 304)



IN.14.124.P
Cabide /
Hook / Percha.
(EN 1.4301 / AISI 304)



IN.14.126.P
Cabide /
Hook / Percha.
(EN 1.4301 / AISI 304)



IN.14.123.P
Cabide /
Hook / Percha.
(EN 1.4301 / AISI 304)



IN.42.165.PP.304 / IN.42.165.PP.316
Porta piaçaba de parede /
Wall toilet brush / Escobillero de pared
(EN 1.4301 / AISI 304 - EN 1.4401 / AISI 316)



IN.53.201.P
Porta rolos /
Paper holder / Soporte de papel.
(EN 1.4301 / AISI 304)



IN.53.202.P
Porta rolos vertical /
Vertical paper holder / Soporte de papel vertical.
(EN 1.4301 / AISI 304)



IN.42.165.P.304 / IN.42.165.P.316
Porta piaçaba /
Toilet brush / Escobillero.
(EN 1.4301 / AISI 304 - EN 1.4401 / AISI 316)

BRANCH SERIES

ACESSÓRIOS PARA CASA DE BANHO /
BATHROOM ACCESSORIES /
ACCESORIOS DE BAÑO.





BRANCH SERIES

ACESSÓRIOS PARA CASA DE BANHO /
 BATHROOM ACCESSORIES /
 ACCESORIOS DE BAÑO.

IN.52.304.---

IN.52.304.---.P

Toalheiro / Towel holder / Toallero.

Design: Christian Magalhães



MATERIAL: EN 1.4301 / AISI 304

ACABAMENTO / FINISH / ACABADO:

IN.53.304: SATINADO / SATIN / SATIN

IN.53.304.P: POLIDO / POLISHED / PULIDO

OPTIONAL: PVD TITANIUM COATED

.TB / .TG / .TCO / .TCH

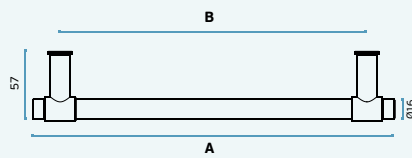

REF	A	B
IN.53.304.250	250mm	269mm
IN.53.304.425	425mm	444mm
IN.53.304.600	600mm	619mm

.P
Mirror
finish

.TB
PVD
Titanium
black

.TG
PVD
Titanium
gold

.TCO
PVD
Titanium
copper

.TCH
PVD
Titanium
chocolate

IN.14.300.14.3

IN.14.300.14.3.P

Cabide de parede triplo /

Triple wall hook / Percha triple.

Design: Christian Magalhães



MATERIAL: EN 1.4301 / AISI 304

ACABAMENTO / FINISH / ACABADO:

IN.14.300.14.3: SATINADO / SATIN

IN.14.300.14.3.P: POLIDO / POLISHED

OPTIONAL: PVD TITANIUM COATED

.TB / .TG / .TCO / .TCH

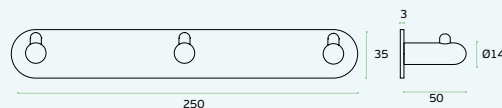

IN.14.300.14

IN.14.300.14.P

Cabide de parede /

Wall hook / Percha

Design: Christian Magalhães



EN 1.4301 / AISI 304

STANDARD FINISH:

SATINADO / SATIN / SATIN

POLIDO / POLISHED / PULIDO

OPTIONAL: PVD TITANIUM

.TB / .TG / .TCO / .TCH

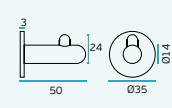

IN.14.300.19.3

IN.14.300.19.3.P

Cabide de parede triplo /

Triple wall hook / Percha triple.

Design: Christian Magalhães



MATERIAL: EN 1.4301 / AISI 304

ACABAMENTO / FINISH / ACABADO:

IN.14.300.19.3: SATINADO / SATIN

IN.14.300.19.3.P: POLIDO / POLISHED

OPTIONAL: PVD TITANIUM COATED

.TB / .TG / .TCO / .TCH



IN.14.300.19

IN.14.300.19.P

Cabide de parede /

Wall hook / Percha

Design: Christian Magalhães



EN 1.4301 / AISI 304

STANDARD FINISH:

SATINADO / SATIN / SATIN

POLIDO / POLISHED / PULIDO

OPTIONAL: PVD TITANIUM

.TB / .TG / .TCO / .TCH

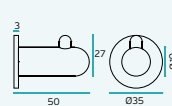

.P
Mirror
finish

.TB
PVD
Titanium
black

.TG
PVD
Titanium
gold

.TCO
PVD
Titanium
copper

.TCH
PVD
Titanium
chocolate

IN.52.305
IN.52.305.P
Estante de parede /
Wall holder / Estante de pared.
Design: Christian Magalhães



MATERIAL: EN 1.4301 / AISI 304

ACABAMENTO / FINISH / ACABADO:

IN.53.305: SATINADO / SATIN / SATIN

IN.53.305.P: POLIDO / POLISHED / PULIDO

OPTIONAL: PVD TITANIUM COATED

.TB / .TG / .TCO / .TCH

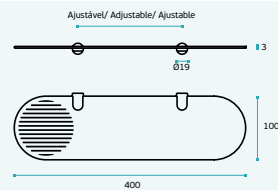

IN.52.306
IN.52.306.P
Estante de parede /
Wall holder / Estante de pared.
Design: Christian Magalhães



MATERIAL: EN 1.4301 / AISI 304

ACABAMENTO / FINISH / ACABADO:

IN.53.306: SATINADO / SATIN / SATIN

IN.53.306.P: POLIDO / POLISHED / PULIDO

OPTIONAL: PVD TITANIUM COATED

.TB / .TG / .TCO / .TCH

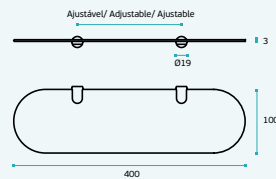

IN.52.302
IN.52.302.P
Porta rolos /
Paper holder / Soporte de papel.
Design: Christian Magalhães



MATERIAL: EN 1.4301 / AISI 304

ACABAMENTO / FINISH / ACABADO:

IN.53.302: SATINADO / SATIN / SATIN

IN.53.302.P: POLIDO / POLISHED / PULIDO

OPTIONAL: PVD TITANIUM COATED

.TB / .TG / .TCO / .TCH

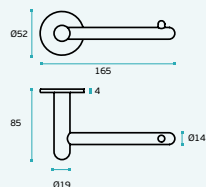

IN.52.308
IN.52.308.P
Saboneteira /
Soap holder / Jabonera.
Design: Christian Magalhães



MATERIAL: EN 1.4301 / AISI 304

ACABAMENTO / FINISH / ACABADO:

IN.53.308: SATINADO / SATIN / SATIN

IN.53.308.P: POLIDO / POLISHED / PULIDO

OPTIONAL: PVD TITANIUM COATED

.TB / .TG / .TCO / .TCH

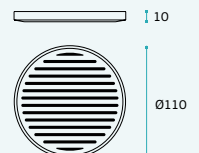

BRANCH SERIES

ACESSÓRIOS PARA CASA DE BANHO /
 BATHROOM ACCESSORIES /
 ACCESORIOS DE BAÑO.

IN.52.303 IN.52.303.P

Porta rolos vertical / Vertical paper
 holder / Soporte de papel vertical.



MATERIAL: EN 1.4301 / AISI 304

ACABAMENTO / FINISH / ACABADO:
 IN.52.303: SATINADO / SATIN / SATIN
 IN.52.303.P: POLIDO / POLISHED / PULIDO

OPTIONAL: PVD TITANIUM COATED

.TB / .TG / .TCO / .TCH

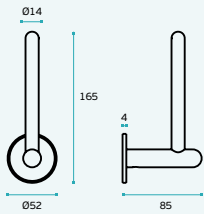

IN.52.301 IN.52.301.P

Porta piaçaba / Toilet brush / Escobillero
 Design: Christian Magalhães



MATERIAL: EN 1.4301 / AISI 304

ACABAMENTO / FINISH / ACABADO:
 IN.52.301: SATINADO / SATIN / SATIN
 IN.52.301.P: POLIDO / POLISHED / PULIDO

OPTIONAL: PVD TITANIUM COATED

.TB / .TG / .TCO / .TCH

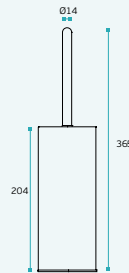

.P
 Mirror
 finish

.TB
 PVD
 Titanium
 black

.TG
 PVD
 Titanium
 gold

.TCO
 PVD
 Titanium
 copper

.TCH
 PVD
 Titanium
 chocolate

IN.52.300 IN.52.300.P

Porta piaçaba com porta rolo /
 Toilet brush with paper holder /
 Escobillero con soporte de papel.
 Design: Christian Magalhães



MATERIAL: EN 1.4301 / AISI 304

ACABAMENTO / FINISH / ACABADO:
 IN.52.300: SATINADO / SATIN / SATIN
 IN.52.300.P: POLIDO / POLISHED / PULIDO

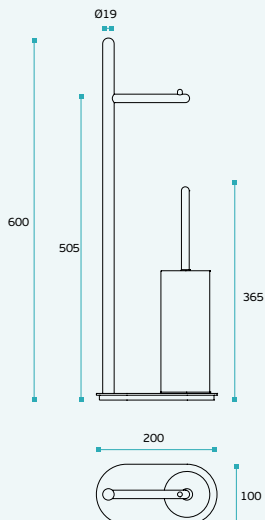

IN.52.307 IN.52.307.P

Porta piaçaba de parede /
 Wall toilet brush /
 Escobillero de pared
 Design: Christian Magalhães



MATERIAL: EN 1.4301 / AISI 304

ACABAMENTO / FINISH / ACABADO:
 IN.52.307: SATINADO / SATIN / SATIN
 IN.52.307.P: POLIDO / POLISHED / PULIDO

OPTIONAL: PVD TITANIUM COATED

.TB / .TG / .TCO / .TCH

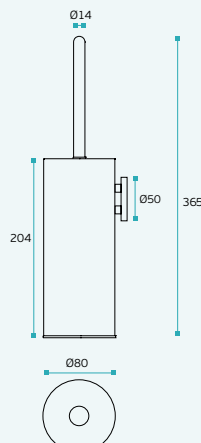

.P
Mirror
finish

.TB
PVD
Titanium
black

.TG
PVD
Titanium
gold

.TCO
PVD
Titanium
copper

.TCH
PVD
Titanium
chocolate



IN.52.304.P
Toalheiro / Towel holder / Toallero.
(EN 1.4301 / AISI 304)



IN.52.303.P
Porta rolos vertical /
Vertical paper holder / Soporte de papel vertical.
(EN 1.4301 / AISI 304)



IN.14.300.14.3.P / IN.14.300.19.3.P
Cabide de parede tripla /
Triple wall hook / Percha triple.
(EN 1.4301 / AISI 304)



IN.52.302.P
Porta rolos /
Paper holder / Soporte de papel.
(EN 1.4301 / AISI 304)



IN.52.308.P
Saboneteira /
Soap holder / Jabonera.
(EN 1.4301 / AISI 304)



IN.14.300.14.P / IN.14.300.19.P
Cabide /
Hook / Percha.
(EN 1.4301 / AISI 304)



IN.52.301.P / IN.52.307.P
Porta piaçaba de parede /
Wall toilet brush / Escobillero de pared
(EN 1.4301 / AISI 304)



IN.52.305.P
Estante de parede /
Wall holder / Estante de pared.
(EN 1.4301 / AISI 304)



IN.52.306.P
Estante de parede /
Wall holder / Estante de pared.
(EN 1.4301 / AISI 304)



IN.52.300.P
Porta piaçaba com porta rolos /
Toilet brush / Escobillero con soporte de papel
(EN 1.4301 / AISI 304)

SLIM BLACK SERIES

ACESSÓRIOS PARA CASA DE BANHO /
BATHROOM ACCESSORIES /
ACCESORIOS DE BAÑO.

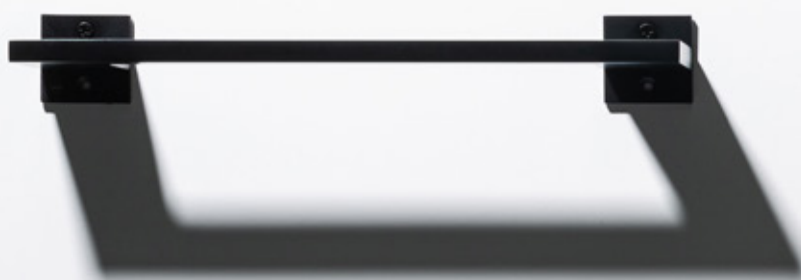



SLIM BLACK SERIES

ACESSÓRIOS PARA CASA DE BANHO /
 BATHROOM ACCESSORIES /
 ACCESORIOS DE BAÑO.

NEW

IN.44.201.

Toalheiro / Towel holder / Toallero.

Design: Christian Magalhães



MATERIAL: ALUMINIO / ALUMINIUM

ACABAMENTO / FINISH / ACABADO:
 STANDARD: RAL 9005

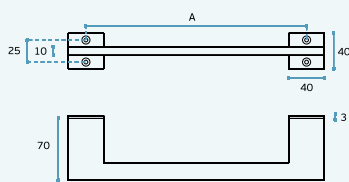

REF	A
IN.44.201.250	250mm
IN.44.201.425	425mm
IN.44.201.600	600mm

.P
 Mirror
 finish

.TB
 PVD
 Titanium
 black

.TG
 PVD
 Titanium
 gold

.TCO
 PVD
 Titanium
 copper

.TCH
 PVD
 Titanium
 chocolate

NEW

IN.44.202

Porta rolo de parede horizontal ou
 vertical / Wall paper holder horizontal
 or vertical / Soporte de papel de pared
 horizontal o vertical.

Design: Christian Magalhães



MATERIAL: ALUMINIO / ALUMINIUM

ACABAMENTO / FINISH / ACABADO:
 STANDARD: RAL 9005

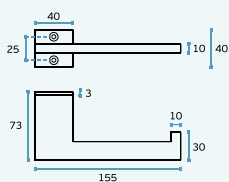

NEW

IN.44.203

Porta rolo de parede duplo /
 Double wall paper holder /
 Soporte de papel doble.

Design: Christian Magalhães



MATERIAL: ALUMINIO / ALUMINIUM

ACABAMENTO / FINISH / ACABADO:
 STANDARD: RAL 9005

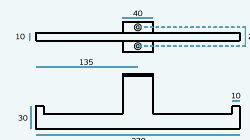

NEW

IN.14.204

Cabide / Wall hook / Colgador

Design: Christian Magalhães



MATERIAL: ALUMINIO / ALUMINIUM

ACABAMENTO / FINISH / ACABADO:
 STANDARD: RAL 9005

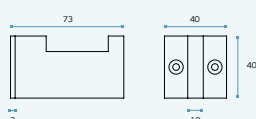

NEW

IN.44.206

Saboneteira de bancada /
 Table soap holder /
 Jabonera de lavado.

Design: Christian Magalhães



MATERIAL: ALUMINIO / ALUMINIUM

ACABAMENTO / FINISH / ACABADO:
 STANDARD: RAL 9005

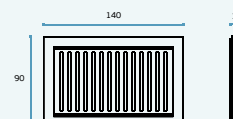



SLIM BLACK SERIES

ACESSÓRIOS PARA CASA DE BANHO /
 BATHROOM ACCESSORIES /
 ACCESORIOS DE BAÑO.

NEW

IN.44.205

Porta piaçaba /

Toilet brush / Escobillero

IN.44.205.P

Porta piaçaba de parede /

Wall toilet brush /

Escobillero de pared

Design: Christian Magalhães

MATERIAL: EN 1.4301 / AISI 304

ACABAMENTO / FINISH / ACABADO:
 STANDARD: RAL 9005

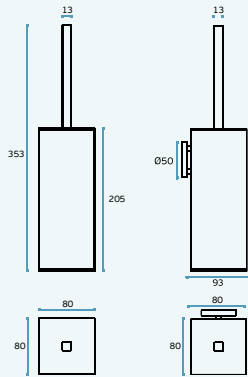

NEW

IN.44.205.W

Porta piaçaba /

Toilet brush / Escobillero

IN.44.205.P.W

Porta piaçaba de parede /

Wall toilet brush /

Escobillero de pared

Design: Christian Magalhães

MATERIAL: EN 1.4301 / AISI 304

ACABAMENTO / FINISH / ACABADO:
 STANDARD: RAL 9016

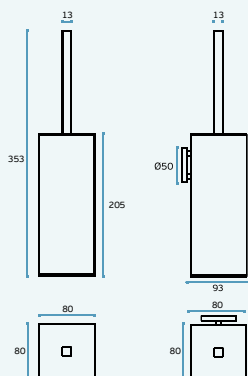
.P
Mirror
finish

SLIM WHITE SERIES

ACESSÓRIOS PARA CASA DE BANHO / BATHROOM ACCESSORIES / ACCESORIOS DE BAÑO.

NEW

IN.44.201.____.W

Toalheiro / Towel holder / Toallero.

Design: Christian Magalhães



MATERIAL: ALUMINIO / ALUMINIUM
ACABAMENTO / FINISH / ACABADO: STANDARD: RAL 9016

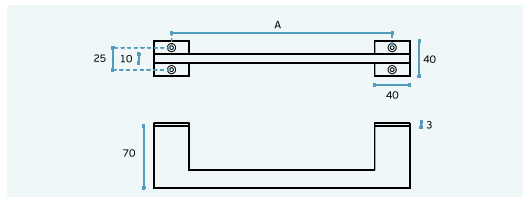

REF	A
IN.44.201.250.W	250mm
IN.44.201.425.W	425mm
IN.44.201.600.W	600mm

.P
Mirror finish

.TB
PVD Titanium black

.TG
PVD Titanium gold

.TCO
PVD Titanium copper

.TCH
PVD Titanium chocolate

NEW

IN.44.202.W

Porta rolo de parede horizontal ou vertical / Wall paper holder horizontal or vertical / Soporte de papel de pared horizontal o vertical.

Design: Christian Magalhães



MATERIAL: ALUMINIO / ALUMINIUM
ACABAMENTO / FINISH / ACABADO: STANDARD: RAL 9016

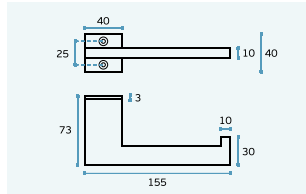

NEW

IN.44.203.W

Porta rolo de parede duplo / Double wall paper holder / Soporte de papel doble.

Design: Christian Magalhães



MATERIAL: ALUMINIO / ALUMINIUM
ACABAMENTO / FINISH / ACABADO: STANDARD: RAL 9016

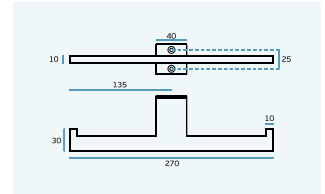

NEW

IN.14.204.W

Cabide / Wall hook / Colgador

Design: Christian Magalhães



MATERIAL: ALUMINIO / ALUMINIUM
ACABAMENTO / FINISH / ACABADO: STANDARD: RAL 9016

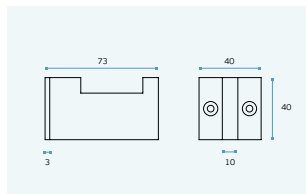

NEW

IN.44.206.W

Saboneteira de bancada / Table soap holder / Jabonera de lavado.

Design: Christian Magalhães



MATERIAL: ALUMINIO / ALUMINIUM
ACABAMENTO / FINISH / ACABADO: STANDARD: RAL 9016

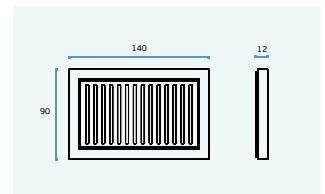

WHITE Q SERIES

ACESSÓRIOS PARA CASA DE BANHO /
BATHROOM ACCESSORIES /
ACCESORIOS DE BAÑO.



.P
Mirror
finish

IN.52.400

Toalheiro / Towel holder / Toallero.
Design: Christian Magalhães



MATERIAL: EN 1.4301 / AISI 304

ACABAMENTO / FINISH / ACABADO:
STANDARD: SATINADO / SATIN / SATIN

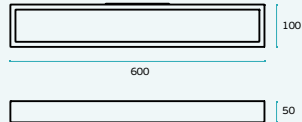

.TB
PVD
Titanium
black

.TG
PVD
Titanium
gold

.TCO
PVD
Titanium
copper

.TCH
PVD
Titanium
chocolate

IN.52.400.A

Estante de parede /
Wall holder /
Estante de pared.
Design: Christian Magalhães

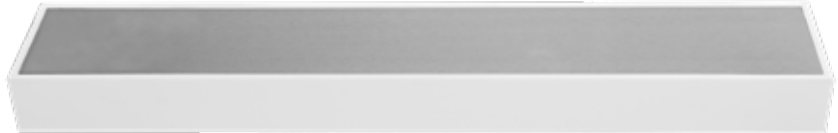

MATERIAL: EN 1.4301 / AISI 304

ACABAMENTO / FINISH / ACABADO:
STANDARD: SATINADO / SATIN / SATIN

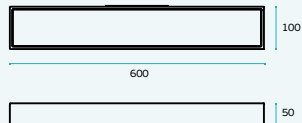

IN.52.400.B

Estante de parede /
Wall holder /
Estante de pared.
Design: Christian Magalhães



MATERIAL: EN 1.4301 / AISI 304

ACABAMENTO / FINISH / ACABADO:
STANDARD: SATINADO / SATIN / SATIN

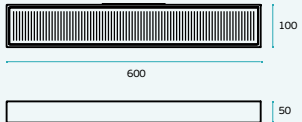

IN.52.400.C

Estante de parede /
Wall holder /
Estante de pared.
Design: Christian Magalhães

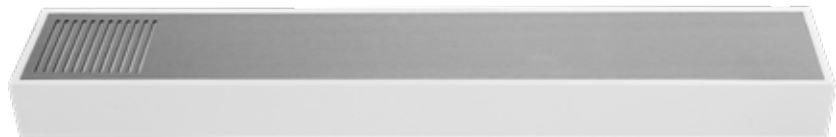

MATERIAL: EN 1.4301 / AISI 304

ACABAMENTO / FINISH / ACABADO:
STANDARD: SATINADO / SATIN / SATIN

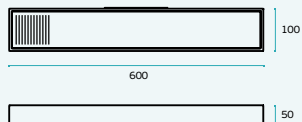

WHITE Q SERIES

ACESSÓRIOS PARA CASA DE BANHO /
 BATHROOM ACCESSORIES /
 ACCESORIOS DE BAÑO.

IN.52.404

Saboneteira de bancada /

Table soap holder /
 Jabonera de lavado.

Design: Christian Magalhães



MATERIAL: EN 1.4301 / AISI 304

ACABAMENTO / FINISH / ACABADO:
 STANDARD: SATINADO / SATIN / SATIN

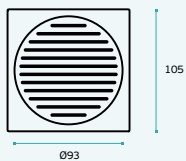

IN.14.400

Cabide de parede /

Wwall hook / Percha

Design: Christian Magalhães



MATERIAL: EN 1.4301 / AISI 304

ACABAMENTO / FINISH / ACABADO:
 STANDARD: SATINADO / SATIN / SATIN

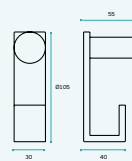

.P
 Mirror
 finish

.TB
 PVD
 Titanium
 black

.TG
 PVD
 Titanium
 gold

.TCO
 PVD
 Titanium
 copper

.TCH
 PVD
 Titanium
 chocolate

IN.52.402

Porta rolo /

Paper holder / Soporte de papel.
 Design: Christian Magalhães



MATERIAL: EN 1.4301 / AISI 304

ACABAMENTO / FINISH / ACABADO:
 STANDARD: SATINADO / SATIN / SATIN

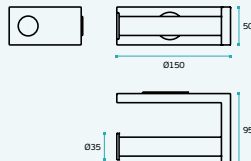

IN.52.401

Porta piaçaba /

Toilet brush / Escobillero

Design: Christian Magalhães

MATERIAL: EN 1.4301 / AISI 304

ACABAMENTO / FINISH / ACABADO:
 STANDARD: SATINADO / SATIN / SATIN

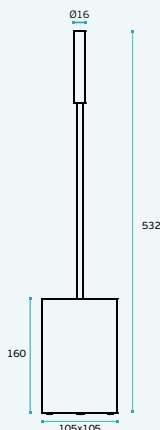

IN.52.403

Dispensador de sabão /

Soap dispenser / Dispensador de jabón
 Design: Christian Magalhães

MATERIAL: EN 1.4301 / AISI 304

ACABAMENTO / FINISH / ACABADO:
 STANDARD: SATINADO / SATIN / SATIN

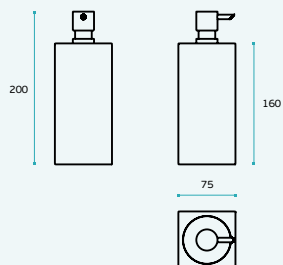



WHITE SERIES

ACESSÓRIOS PARA CASA DE BANHO /
 BATHROOM ACCESSORIES /
 ACCESORIOS DE BAÑO.

IN.52.500

Toalheiro / Towel holder / Toallero.
Design: Christian Magalhães

MATERIAL: EN 1.4301 / AISI 304

ACABAMENTO / FINISH / ACABADO:
STANDARD: SATINADO / SATIN / SATIN

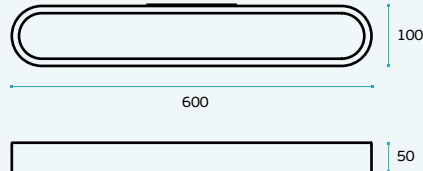

IN.52.500.A

Estante de parede /
 Wall holder /
 Estante de pared.

Design: Christian Magalhães

MATERIAL: EN 1.4301 / AISI 304

ACABAMENTO / FINISH / ACABADO:
STANDARD: SATINADO / SATIN / SATIN

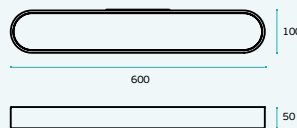
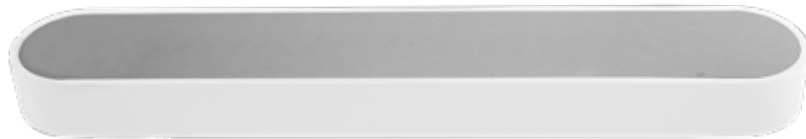

IN.52.500.B

Estante de parede /
 Wall holder /
 Estante de pared.

Design: Christian Magalhães

MATERIAL: EN 1.4301 / AISI 304

ACABAMENTO / FINISH / ACABADO:
STANDARD: SATINADO / SATIN / SATIN

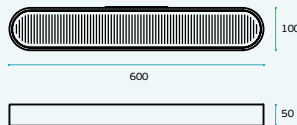

IN.52.500.C

Estante de parede /
 Wall holder /
 Estante de pared.

Design: Christian Magalhães

MATERIAL: EN 1.4301 / AISI 304

ACABAMENTO / FINISH / ACABADO:
STANDARD: SATINADO / SATIN / SATIN

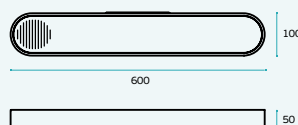

IN.14.502

Cabide de parede /
Wall hook / Percha
Design: Christian Magalhães



MATERIAL: EN 1.4301 / AISI 304

ACABAMENTO / FINISH / ACABADO:
STANDARD: SATINADO / SATIN / SATIN

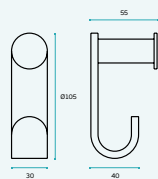

IN.52.504

Saboneteira de bancada /
Table soap holder /
Jabonera de lavado.
Design: Christian Magalhães



MATERIAL: EN 1.4301 / AISI 304

ACABAMENTO / FINISH / ACABADO:
STANDARD: SATINADO / SATIN / SATIN

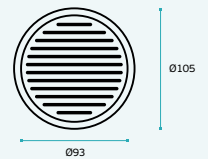

IN.52.503

Dispensador de sabão /
Soap Dispenser /
Dispensador de jabón
Design: Christian Magalhães



MATERIAL: EN 1.4301 / AISI 304

ACABAMENTO / FINISH / ACABADO:
STANDARD: SATINADO / SATIN / SATIN

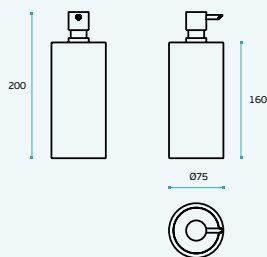

IN.52.501

Porta piaçaba /
Toilet brush / Escobillero
Design: Christian Magalhães

MATERIAL: EN 1.4301 / AISI 304

ACABAMENTO / FINISH / ACABADO:
STANDARD: SATINADO / SATIN / SATIN

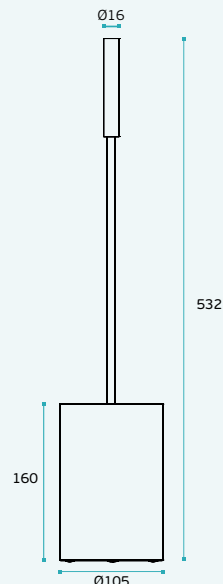

IN.52.502

Porta rolo /
Paper holder / Soporte de papel.
Design: Christian Magalhães



MATERIAL: EN 1.4301 / AISI 304

ACABAMENTO / FINISH / ACABADO:
STANDARD: SATINADO / SATIN / SATIN

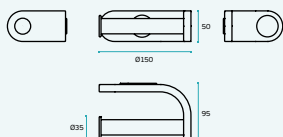

WENGÉ SERIES

ACESSÓRIOS PARA CASA DE BANHO /
BATHROOM ACCESSORIES /
ACCESORIOS DE BAÑO.





WENGÉ SERIES

ACESSÓRIOS PARA CASA DE BANHO /
 BATHROOM ACCESSORIES /
 ACCESORIOS DE BAÑO.

IN.53.100.

Toalheiro / Towel holder / Toallero.
Design: Pedro Queirós



MATERIAL: EN 1.4301 / AISI 304 +
 MADEIRA / WOOD / MADERA

ACABAMENTO / FINISH / ACABADO:
STANDARD: SATINADO / SATIN / SATIN

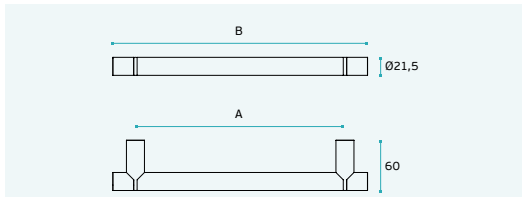

REF	A	B
IN.53.100.250	250mm	305mm
IN.53.100.425	425mm	480mm
IN.53.100.600	600mm	655mm

IN.53.101

Toalheiro duplo /
 Double towel holder / Toallero doble.
Design: Pedro Queirós



MATERIAL: EN 1.4301 / AISI 304 +
 MADEIRA / WOOD / MADERA

ACABAMENTO / FINISH / ACABADO:
STANDARD: SATINADO / SATIN / SATIN

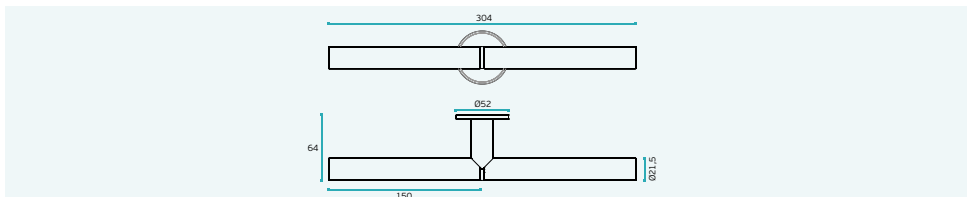

IN.53.103

Porta rolo /
 Paper holder /
 Soporte de papel
Design: Pedro Queirós



MATERIAL: EN 1.4301 / AISI 304 +
 MADEIRA / WOOD / MADERA

ACABAMENTO / FINISH / ACABADO:
STANDARD: SATINADO / SATIN / SATIN

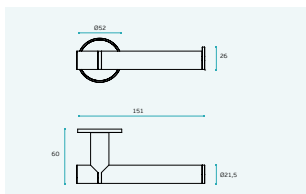

IN.14.418

Cabide /
 Hook / Percha.
Design: Pedro Queirós



MATERIAL: EN 1.4301 / AISI 304 +
 MADEIRA / WOOD / MADERA

ACABAMENTO / FINISH / ACABADO:
STANDARD: SATINADO / SATIN / SATIN

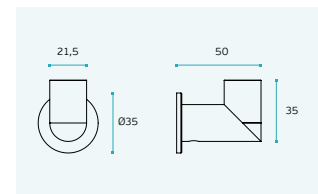



IN.53.102.P

Porta piaçaba de parede /
Wall toilet brush /
Escobillero de pared
Design: Pedro Queirós

MATERIAL: EN 1.4301 / AISI 304 +
MADEIRA / WOOD / MADERA

ACABAMENTO / FINISH / ACABADO:
STANDARD: SATINADO / SATIN / SATIN

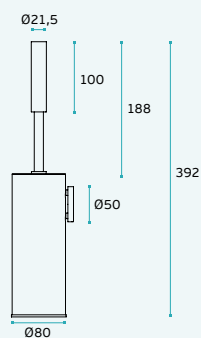

IN.53.102

Porta piaçaba /
Toilet brush /
Escobillero.
Design: Pedro Queirós

MATERIAL: EN 1.4301 / AISI 304 +
MADEIRA / WOOD / MADERA

ACABAMENTO / FINISH / ACABADO:
STANDARD: SATINADO / SATIN / SATIN

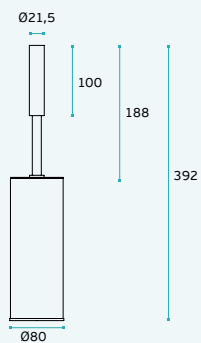

2D SERIES

ACESSÓRIOS PARA CASA DE BANHO /
BATHROOM ACCESSORIES /
ACCESORIOS DE BAÑO.





2D SERIES

ACESSÓRIOS PARA CASA DE BANHO /
 BATHROOM ACCESSORIES /
 ACCESORIOS DE BAÑO.

IN.53.002. _ _ _
Toalheiro /
 Towel holder / Toallero.



MATERIAL: EN 1.4301 / AISI 304
ACABAMENTO / FINISH / ACABADO:
STANDARD: SATINADO / SATIN / SATIN

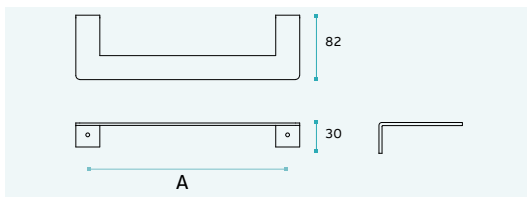

REF	A
IN.52.002.250	250mm
IN.52.002.425	425mm
IN.52.002.600	600mm

.P
 Mirror
 finish

.TB
 PVD
 Titanium
 black

.TG
 PVD
 Titanium
 gold

.TCO
 PVD
 Titanium
 copper

.TCH
 PVD
 Titanium
 chocolate

IN.53.001
Saboneteira de parede /
 Wall soap holder / Jabonera de pared.



MATERIAL: EN 1.4301 / AISI 304
ACABAMENTO / FINISH / ACABADO:
STANDARD: SATINADO / SATIN / SATIN

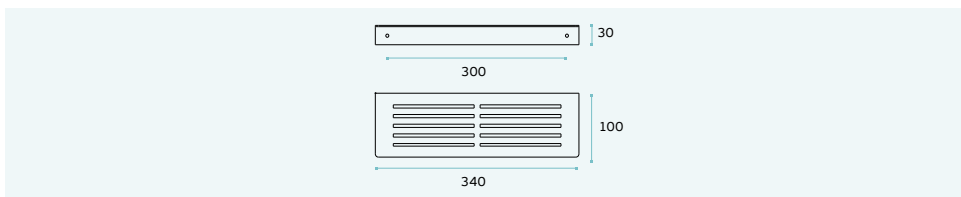

IN.53.006
Saboneteira de parede /
 Wall soap holder / Jabonera de pared.



MATERIAL: EN 1.4301 / AISI 304
ACABAMENTO / FINISH / ACABADO:
STANDARD: SATINADO / SATIN / SATIN

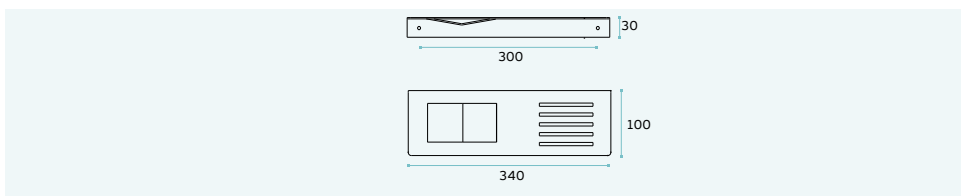

.P
Mirror
finish

.TB
PVD
Titanium
black

.TG
PVD
Titanium
gold

.TCO
PVD
Titanium
copper

.TCH
PVD
Titanium
chocolate

IN.53.003

Porta rolo /
Paper holder /
Soporte de papel.



MATERIAL: EN 1.4301 / AISI 304

ACABAMENTO / FINISH / ACABADO:
STANDARD: SATINADO / SATIN / SATIN

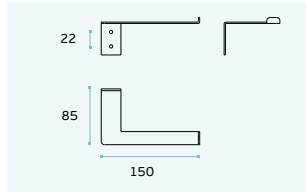

IN.53.004

Porta rolo vertical /
Vertical paper holder /
Soporte de papel vertical.



MATERIAL: EN 1.4301 / AISI 304

ACABAMENTO / FINISH / ACABADO:
STANDARD: SATINADO / SATIN / SATIN

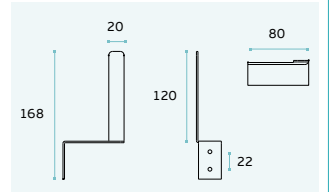

IN.53.005

Porta rolo com tampa /
Paper holder with cover /
Soporte de papel con cubierta.



MATERIAL: EN 1.4301 / AISI 304

ACABAMENTO / FINISH / ACABADO:
STANDARD: SATINADO / SATIN / SATIN

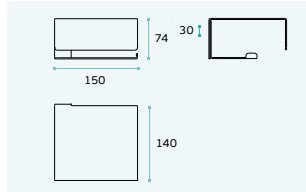

RV.48.003

Porta piaçaba de parede /
Wall toilet brush /
Escobillero de pared.
Design: Rui Viana

MATERIAL: EN 1.4301 / AISI 304

ACABAMENTO / FINISH / ACABADO:
STANDARD: SATINADO / SATIN / SATIN

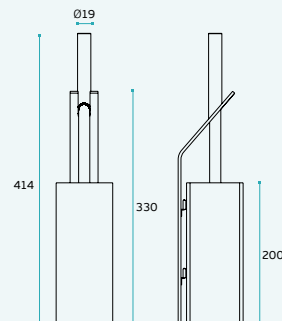

IN.14.541

Cabide /
Hook /
Percha.



MATERIAL: EN 1.4301 / AISI 304

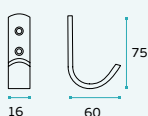

IN.14.540

Cabide /
Hook /
Percha.



MATERIAL: EN 1.4301 / AISI 304

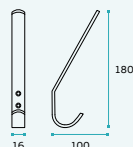

K/1054



Acessórios para casa de banho /
Bathroom accessories /
Accesorios de baño.

Tonda
Series

WWW.JNF.PT

TONDA SERIES

ACESSÓRIOS PARA CASA DE BANHO /
BATHROOM ACCESSORIES /
ACCESORIOS DE BAÑO.





TONDA SERIES

ACESSÓRIOS PARA CASA DE BANHO /
 BATHROOM ACCESSORIES /
 ACCESORIOS DE BAÑO.

IN.41.141.16. _ _ _

IN.41.141.19. _ _ _

Toalheiro /
 Towel holder /
 Toallero.



MATERIAL: EN 1.4301 / AISI 304

ACABAMENTO / FINISH / ACABADO:
STANDARD: SATINADO / SATIN / SATIN

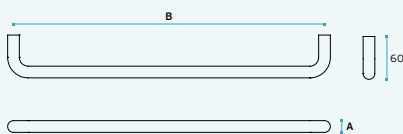

REF	A	B
IN.41.141. _ _ _ 250	16mm 19mm	250mm
IN.41.141. _ _ _ 425	16mm 19mm	425mm
IN.41.141. _ _ _ 600	16mm 19mm	600mm

IN.41.141.19. _ _ _ **.P**

Toalheiro /
 Towel holder /
 Toallero.



MATERIAL: EN 1.4301 / AISI 304

ACABAMENTO / FINISH / ACABADO:
POLIDO / POLISHED / PULIDO

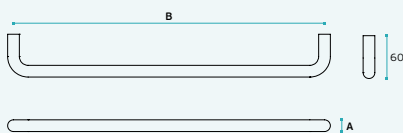

REF	A	B
IN.41.141.19.250.P	19mm	250mm
IN.41.141.19.425.P	19mm	425mm
IN.41.141.19.600.P	19mm	600mm

IN.41.132

Estante para toalhas /
 Towel holder /
 Estante toallero

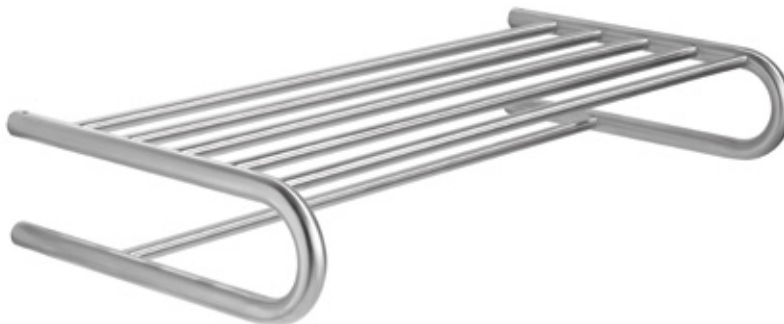

MATERIAL: EN 1.4301 / AISI 304

ACABAMENTO / FINISH / ACABADO:
STANDARD: SATINADO / SATIN / SATIN

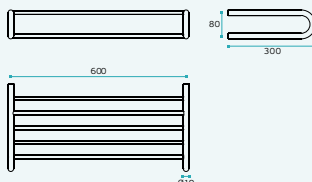

IN.41.132.P
Estante para toalhas /
Towel holder /
Estante toallero



MATERIAL: EN 1.4301 / AISI 304

ACABAMENTO / FINISH / ACABADO:
POLIDO / POLISHED / PULIDO

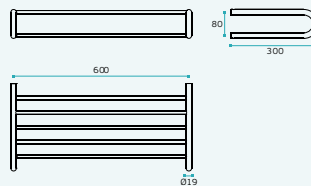

IN.41.135
Porta rolo /
Paper holder /
Soporte de papel



MATERIAL: EN 1.4301 / AISI 304

ACABAMENTO / FINISH / ACABADO:
STANDARD: SATINADO / SATIN / SATIN

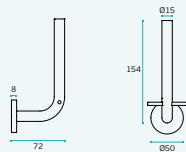

IN.41.137
Saboneteira /
Soap holder / Jabonera



MATERIAL: EN 1.4301 / AISI 304

ACABAMENTO / FINISH / ACABADO:
STANDARD: SATINADO / SATIN / SATIN

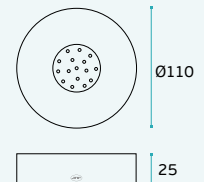

IN.41.136.150
Saboneteira /
Soap holder / Jabonera



MATERIAL: EN 1.4301 / AISI 304

ACABAMENTO / FINISH / ACABADO:
STANDARD: SATINADO / SATIN / SATIN

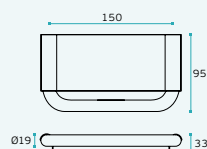

IN.41.136.300
Saboneteira /
Soap holder / Jabonera



MATERIAL: EN 1.4301 / AISI 304

ACABAMENTO / FINISH / ACABADO:
STANDARD: SATINADO / SATIN / SATIN

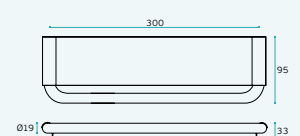

TONDA SERIES

ACESSÓRIOS PARA CASA DE BANHO /
 BATHROOM ACCESSORIES /
 ACCESORIOS DE BAÑO.

IN.41.165

Porta piaçaba de parede /
 Wall toilet brush /
 Escobillero de pared

MATERIAL: EN 1.4301 / AISI 304

ACABAMENTO / FINISH / ACABADO:
 STANDARD: SATINADO / SATIN / SATIN

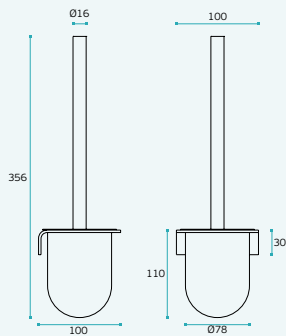

IN.41.320

Porta piaçaba de parede /
 Wall toilet brush /
 Escobillero de pared

MATERIAL: EN 1.4301 / AISI 304

ACABAMENTO / FINISH / ACABADO:
 STANDARD: SATINADO / SATIN / SATIN

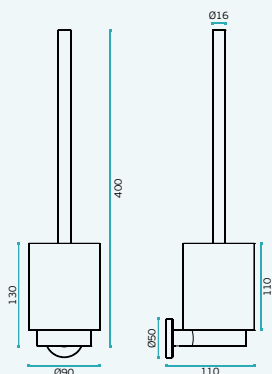

IN.14.525

Cabide ou porta rolo /
Hook or paper holder /
Percha o suporte de papel.



MATERIAL: EN 1.4301 / AISI 304

ACABAMENTO / FINISH / ACABADO: STANDARD:
SATINADO / SATIN / SATIN

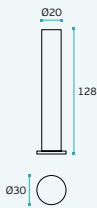

IN.14.520

Cabide /
Hook / Percha.



MATERIAL: EN 1.4301 / AISI 304

ACABAMENTO / FINISH / ACABADO: STANDARD:
SATINADO / SATIN / SATIN



IN.14.526

Cabide /
Hook / Percha.



MATERIAL: EN 1.4301 / AISI 304

ACABAMENTO / FINISH / ACABADO: STANDARD:
SATINADO / SATIN / SATIN

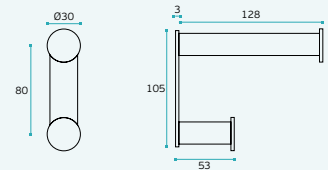

IN.14.520.3

Cabide tripla /
Hook triple / Percha tripla.

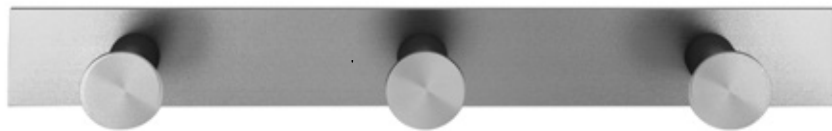

MATERIAL: EN 1.4301 / AISI 304

ACABAMENTO / FINISH / ACABADO: STANDARD:
SATINADO / SATIN / SATIN

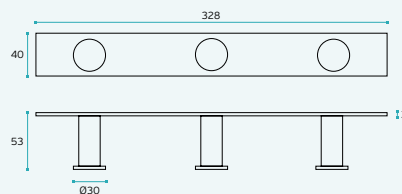

K/1060



Accessórios para casa de banho /
Bathroom accessories /
Accesorios de baño.

Ângulo
Series

WWW.JNF.PT

ÂNGULO SERIES

ACESSÓRIOS PARA CASA DE BANHO /
BATHROOM ACCESSORIES /
ACCESORIOS DE BAÑO.





ÂNGULO SERIES

ACESSÓRIOS PARA CASA DE BANHO /
 BATHROOM ACCESSORIES /
 ACCESORIOS DE BAÑO.

IN.42.145.16. _ _ _

IN.42.145.19. _ _ _

Toalheiro /
 Towel holder /
 Toallero.



MATERIAL: EN 1.4301 / AISI 304

ACABAMENTO / FINISH / ACABADO:
STANDARD: SATINADO / SATIN / SATIN

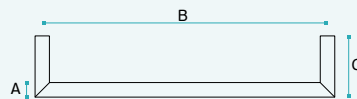

REF	A	B	C
IN.42.145. _ _ . 250	16mm 19mm	250mm	68mm 64mm
IN.42.145. _ _ . 425	16mm 19mm	425mm	68mm 64mm
IN.42.145. _ _ . 600	16mm 19mm	600mm	68mm 64mm

IN.42.145.19. _ _ _ **P**

Toalheiro /
 Towel holder /
 Toallero.



MATERIAL: EN 1.4301 / AISI 304

ACABAMENTO / FINISH / ACABADO:
POLIDO / POLISHED / PULIDO

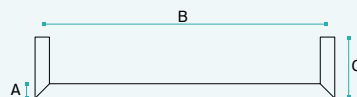

REF	A	B	C
IN.42.145.19.250.P	19mm	250mm	64mm
IN.42.145.19.425.P	19mm	425mm	64mm
IN.42.145.19.600.P	19mm	600mm	64mm

IN.42.144.D

Toalheiro /
 Towel holder /
 Toallero.



MATERIAL: EN 1.4301 / AISI 304

ACABAMENTO / FINISH / ACABADO:
STANDARD: SATINADO / SATIN / SATIN

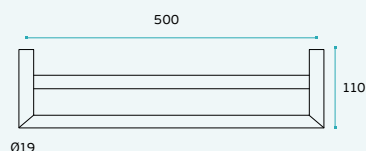

019

IN.42.143

Toalheiro duplo /

Double towel holder / Toallero doble



MATERIAL: EN 1.4301 / AISI 304

ACABAMENTO / FINISH / ACABADO:
STANDARD: SATINADO / SATIN / SATIN

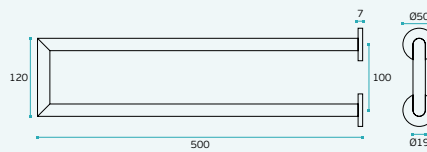

IN.14.510

Cabide /

Hook / Percha.



MATERIAL: EN 1.4301 / AISI 304

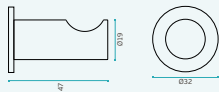

IN.14.515

Cabide /

Hook / Percha.



MATERIAL: EN 1.4301 / AISI 304

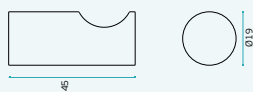

IN.14.537

Cabide /

Hook / Percha.



MATERIAL: EN 1.4301 / AISI 304

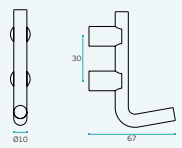

IN.14.527

Cabide /

Hook / Percha.



MATERIAL: EN 1.4301 / AISI 304

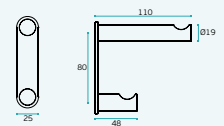

IN.42.144.D.P

Toalheiro /

Towel holder /

Toallero.



MATERIAL: EN 1.4301 / AISI 304

ACABAMENTO / FINISH / ACABADO:
POLIDO / POLISHED / PULIDO

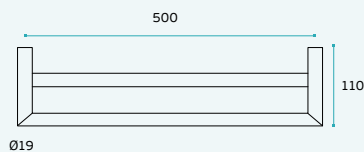

ÂNGULO SERIES

ACESSÓRIOS PARA CASA DE BANHO /
 BATHROOM ACCESSORIES /
 ACCESORIOS DE BAÑO.



IN.42.142 IN.42.142.P

Estante para toalhas /
 Towel holder /
 Estante toallero



MATERIAL: EN 1.4301 / AISI 304

ACABAMENTO / FINISH / ACABADO:
STANDARD: SATINADO / SATIN / SATIN

OPTIONAL:
 POLIDO / POLISHED / PULIDO

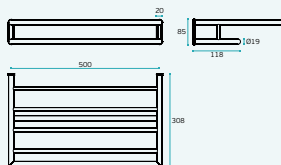

IN.42.134

Porta rolo /
 Paper holder /
 Soporte de papel.



MATERIAL: EN 1.4301 / AISI 304

ACABAMENTO / FINISH / ACABADO:
STANDARD: SATINADO / SATIN / SATIN

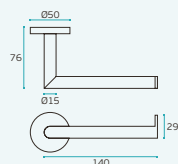

IN.42.134.P

Porta rolo /
 Paper holder /
 Soporte de papel.



MATERIAL: EN 1.4301 / AISI 304

ACABAMENTO / FINISH / ACABADO:
 POLIDO / POLISHED / PULIDO

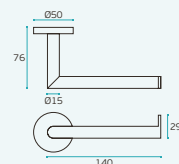

.P
Mirror
finish

.TB
PVD
Titanium
black

.TG
PVD
Titanium
gold

.TCO
PVD
Titanium
copper

.TCH
PVD
Titanium
chocolate

IN.42.146

Saboneteira /
Soap holder / Jabonera



MATERIAL: EN 1.4301 / AISI 304

ACABAMENTO / FINISH / ACABADO:
STANDARD: SATINADO / SATIN / SATIN

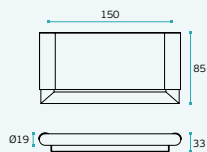

IN.42.148

Saboneteira /
Soap holder / Jabonera



MATERIAL: EN 1.4301 / AISI 304

ACABAMENTO / FINISH / ACABADO:
STANDARD: SATINADO / SATIN / SATIN

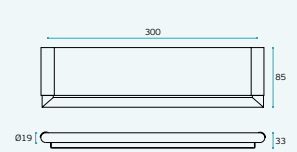

IN.42.144.150

Saboneteira /
Soap holder / Jabonera



MATERIAL: EN 1.4301 / AISI 304

ACABAMENTO / FINISH / ACABADO:
STANDARD: SATINADO / SATIN / SATIN

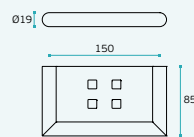

IN.42.144.300

Saboneteira /
Soap holder / Jabonera



MATERIAL: EN 1.4301 / AISI 304

ACABAMENTO / FINISH / ACABADO:
STANDARD: SATINADO / SATIN / SATIN

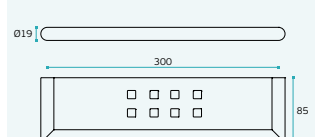

IN.42.144.150.P

Saboneteira /
Soap holder / Jabonera



MATERIAL: EN 1.4301 / AISI 304

ACABAMENTO / FINISH / ACABADO:
POLIDO / POLISHED / PULIDO

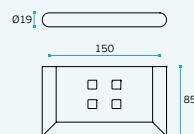

IN.42.144.300.P

Saboneteira /
Soap holder / Jabonera



MATERIAL: EN 1.4301 / AISI 304

ACABAMENTO / FINISH / ACABADO:
POLIDO / POLISHED / PULIDO

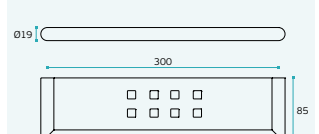

ÂNGULO SERIES

ACESSÓRIOS PARA CASA DE BANHO /
 BATHROOM ACCESSORIES /
 ACCESORIOS DE BAÑO.

IN.42.149

Porta rolo vertical /
 Vertical paper holder /
 Soporte de papel vertical.

MATERIAL: EN 1.4301 / AISI 304

ACABAMENTO / FINISH / ACABADO:
STANDARD: SATINADO / SATIN / SATIN

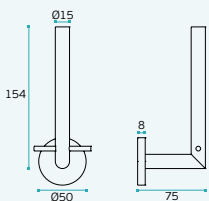

IN.42.165.P.---

Porta piaçaba de parede /
 Wall toilet brush /
 Escobillero de pared

MATERIAL:
IN.42.165.P.304 - EN 1.4301 / AISI 304
IN.42.165.P.316 - EN 1.4401 / AISI 316

ACABAMENTO / FINISH / ACABADO:
STANDARD: SATINADO / SATIN / SATIN

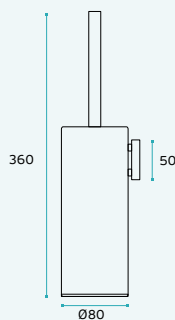

IN.42.149.P

Porta rolo vertical /
 Vertical paper holder /
 Soporte de papel vertical.

MATERIAL: EN 1.4301 / AISI 304

ACABAMENTO / FINISH / ACABADO:
STANDARD: POLIDO / POLISHED / PULIDO

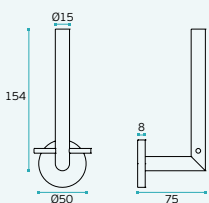

IN.42.164.---

Porta piaçaba /
 Toilet brush /
 Escobillero

MATERIAL:
IN.42.164.304 - EN 1.4301 / AISI 304
IN.42.164.316 - EN 1.4401 / AISI 316

ACABAMENTO / FINISH / ACABADO:
STANDARD: SATINADO / SATIN / SATIN

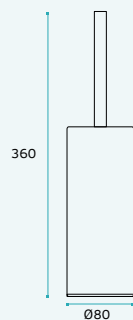

IN.42.165.PP.
Porta piaçaba de parede /
Wall toilet brush /
Escobillero de pared

MATERIAL:
IN.42.165.PP.304 - EN 1.4301 / AISI 304
IN.42.165.PP.316 - EN 1.4401 / AISI 316

ACABAMENTO / FINISH / ACABADO:
POLIDO / POLISHED / PULIDO

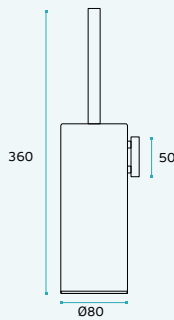

IN.42.166
Porta piaçaba de parede /
Wall toilet brush /
Escobillero de pared

MATERIAL: EN 1.4301 / AISI 304

ACABAMENTO / FINISH / ACABADO:
STANDARD: SATINADO / SATIN / SATIN

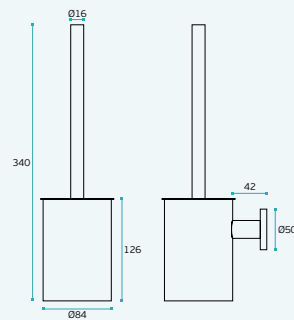

IN.42.164.P.
Porta piaçaba /
Toilet brush /
Escobillero

MATERIAL:
IN.42.164.P.304 - EN 1.4301 / AISI 304
IN.42.164.P.316 - EN 1.4401 / AISI 316

ACABAMENTO / FINISH / ACABADO:
POLIDO / POLISHED / PULIDO

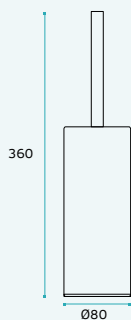

IN.42.310
Porta piaçaba /
Toilet brush /
Escobillero

MATERIAL: EN 1.4301 / AISI 304

ACABAMENTO / FINISH / ACABADO:
STANDARD: SATINADO / SATIN / SATIN

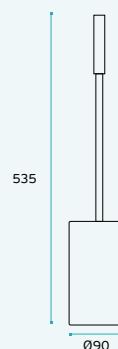

FINE SERIES

ACESSÓRIOS PARA CASA DE BANHO /
BATHROOM ACCESSORIES /
ACCESORIOS DE BAÑO.





FINE SERIES

ACESSÓRIOS PARA CASA DE BANHO /
 BATHROOM ACCESSORIES /
 ACCESORIOS DE BAÑO.

IN.43.150M.

IN.43.150M.P.

Toalheiro /
 Towel holder / Toallero.



MATERIAL: EN 1.4301 / AISI 304

ACABAMENTO / FINISH / ACABADO:
STANDARD: SATINADO / SATIN / SATIN

OPTIONAL:
 POLIDO / POLISHED / PULIDO

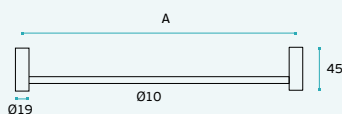

REF	A
IN.43.150M.250 IN.43.150M.P.250	250mm
IN.43.150M.425 IN.43.150M.P.425	425mm
IN.43.150M.600 IN.43.150M.P.600	600mm

IN.43.150.

IN.43.150.P.

Toalheiro /
 Towel holder / Toallero.



MATERIAL: EN 1.4301 / AISI 304

ACABAMENTO / FINISH / ACABADO:
STANDARD: SATINADO / SATIN / SATIN

OPTIONAL:
 POLIDO / POLISHED / PULIDO

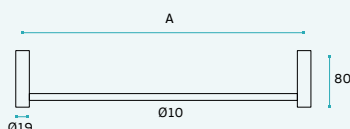

REF	A
IN.43.150.250 IN.43.150.P.250	250mm
IN.43.150.425 IN.43.150.P.425	425mm
IN.43.150.600 IN.43.150.P.600	600mm

IN.43.152

IN.43.152.P

Toalheiro duplo /
 Double towel holder /
 Toallero doble



MATERIAL: EN 1.4301 / AISI 304

ACABAMENTO / FINISH / ACABADO:
STANDARD: SATINADO / SATIN / SATIN

OPTIONAL:
 POLIDO / POLISHED / PULIDO

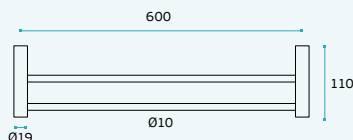

IN.43.152.4
Estante para toalhas /
Towel holder /
Estante toallero

MATERIAL: EN 1.4301 / AISI 304

ACABAMENTO / FINISH / ACABADO:
STANDARD: SATINADO / SATIN / SATIN

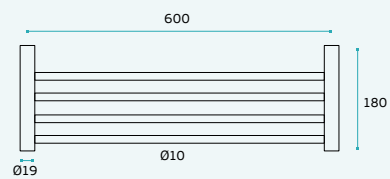

IN.43.174
Estante para toalhas /
Towel holder /
Estante toallero

MATERIAL: EN 1.4301 / AISI 304

ACABAMENTO / FINISH / ACABADO:
STANDARD: SATINADO / SATIN / SATIN

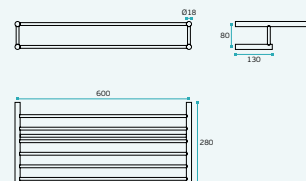

IN.43.174 .P
Estante para toalhas /
Towel holder /
Estante toallero

MATERIAL: EN 1.4301 / AISI 304

ACABAMENTO / FINISH / ACABADO:
POLIDO / POLISHED / PULIDO

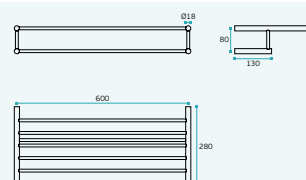
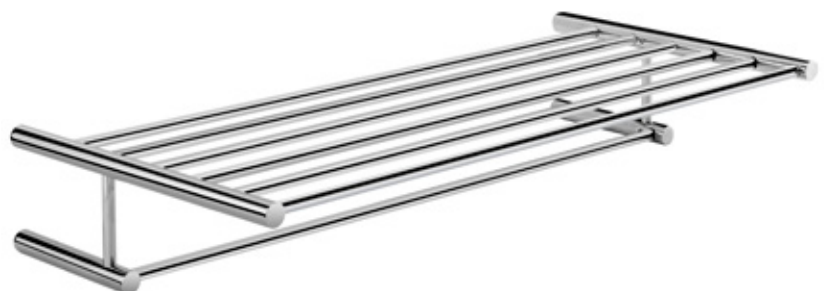

FINE SERIES

ACESSÓRIOS PARA CASA DE BANHO /
 BATHROOM ACCESSORIES /
 ACCESORIOS DE BAÑO.

IN.43.151

Toalheiro duplo giratório /
 Turning double towel holder /
 Toallero giratório doble.



MATERIAL: EN 1.4301 / AISI 304

ACABAMENTO / FINISH / ACABADO:
STANDARD: SATINADO / SATIN / SATIN

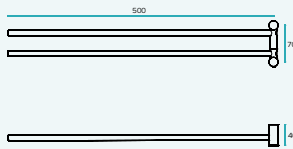

IN.43.159

Porta escovas /
 Teeth brush holder
 Porta cepillos.



MATERIAL: EN 1.4301 / AISI 304

ACABAMENTO / FINISH / ACABADO:
STANDARD: SATINADO / SATIN / SATIN

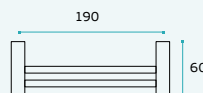

IN.43.153

Toalheiro /
 Towel holder/
 Toallero.



MATERIAL: EN 1.4301 / AISI 304

ACABAMENTO / FINISH / ACABADO:
STANDARD: SATINADO / SATIN / SATIN

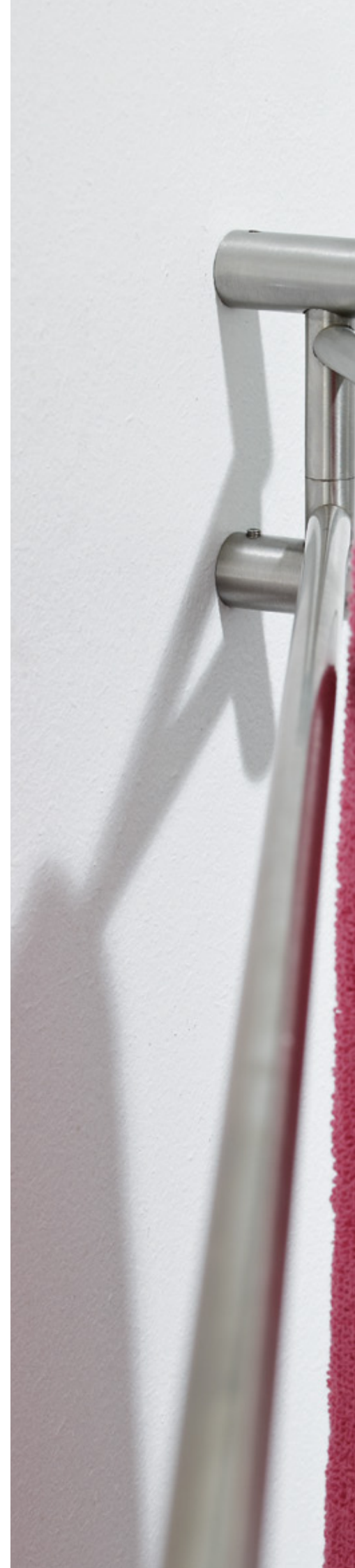
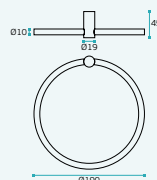

IN.43.486
IN.43.486.P

*Dispensador de sabão /
Soap dispenser / Dispensador de jabon.*

MATERIAL: EN 1.4301 / AISI 304

ACABAMENTO / FINISH / ACABADO:
STANDARD: SATINADO / SATIN / SATIN

OPTIONAL:
POLIDO / POLISHED / PULIDO

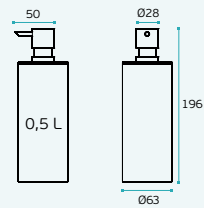

IN.43.485
IN.43.485.P

*Dispensador de sabão de parede /
Wall soap dispenser /
Dispensador de jabón de pared*

MATERIAL: EN 1.4301 / AISI 304

ACABAMENTO / FINISH / ACABADO:
STANDARD: SATINADO / SATIN / SATIN

OPTIONAL:
POLIDO / POLISHED / PULIDO

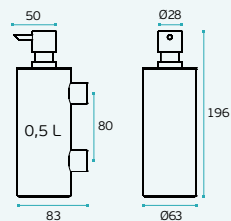

IN.43.167

*Porta piaçaba de parede /
Wall toilet brush / Escobillero de pared*

MATERIAL: EN 1.4301 / AISI 304

ACABAMENTO / FINISH / ACABADO:
STANDARD: SATINADO / SATIN / SATIN

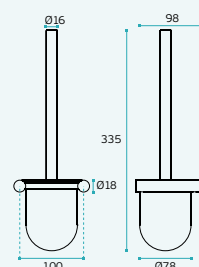

FINE SERIES

ACESSÓRIOS PARA CASA DE BANHO /
 BATHROOM ACCESSORIES /
 ACCESORIOS DE BAÑO.

IN.43.157

Saboneteira /
 Soap holder / Jabonera



MATERIAL: EN 1.4301 / AISI 304

ACABAMENTO / FINISH / ACABADO:
STANDARD: SATINADO / SATIN / SATIN

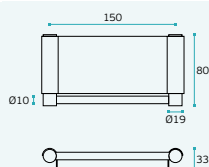

IN.43.158

Saboneteira /
 Soap holder / Jabonera



MATERIAL: EN 1.4301 / AISI 304

ACABAMENTO / FINISH / ACABADO:
STANDARD: SATINADO / SATIN / SATIN

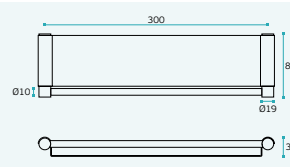

IN.43.186

Saboneteira de bancada /
 Table soap holder /
 Jabonera de lavabo.



MATERIAL: EN 1.4301 / AISI 304

ACABAMENTO / FINISH / ACABADO:
STANDARD: SATINADO / SATIN / SATIN

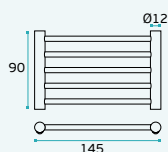

IN.43.183.150

Saboneteira com vidro /
 Soap holder with glass /
 Jabonera con cristal.



MATERIAL: EN 1.4301 / AISI 304

ACABAMENTO / FINISH / ACABADO:
STANDARD: SATINADO / SATIN / SATIN

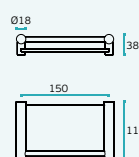

IN.43.184.150

Saboneteira de parede /
 Wall soap holder /
 Jabonera de pared.



MATERIAL: EN 1.4301 / AISI 304

ACABAMENTO / FINISH / ACABADO:
STANDARD: SATINADO / SATIN / SATIN

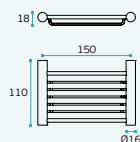

IN.43.184.300

Saboneteira de parede /
 Wall soap holder /
 Jabonera de pared



MATERIAL: EN 1.4301 / AISI 304

ACABAMENTO / FINISH / ACABADO:
STANDARD: SATINADO / SATIN / SATIN

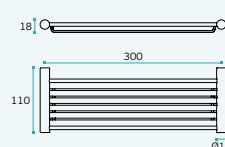

IN.40.138

Porta rolo /
Paper holder /
Soporte de papel.



MATERIAL: EN 1.4301 / AISI 304

ACABAMENTO / FINISH / ACABADO:
STANDARD: SATINADO / SATIN / SATIN

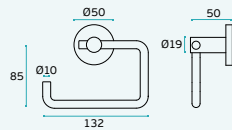

IN.40.139

Porta rolo com tampa /
Paper holder with cover /
Soporte de papel con tampa



MATERIAL: EN 1.4301 / AISI 304

ACABAMENTO / FINISH / ACABADO:
STANDARD: SATINADO / SATIN / SATIN

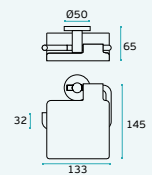

IN.43.183.600

Saboneteira com vidro /
Soap holder with glass /
Jabonera con cristal.



MATERIAL: EN 1.4301 / AISI 304

ACABAMENTO / FINISH / ACABADO: **STANDARD:** SATINADO / SATIN / SATIN

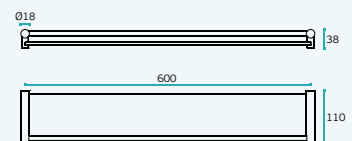

IN.43.156

Porta rolo duplo /
Double Paper holder /
Soporte de papel doble.



MATERIAL: EN 1.4301 / AISI 304

ACABAMENTO / FINISH / ACABADO:
STANDARD: SATINADO / SATIN / SATIN

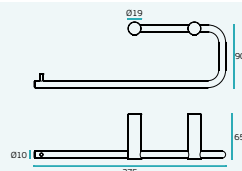

IN.43.155

Porta rolo /
Paper holder /
Soporte de papel.



MATERIAL: EN 1.4301 / AISI 304

ACABAMENTO / FINISH / ACABADO:
STANDARD: SATINADO / SATIN / SATIN

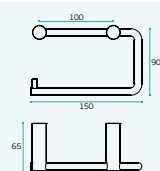

FINE SERIES

ACESSÓRIOS PARA CASA DE BANHO /
 BATHROOM ACCESSORIES /
 ACCESORIOS DE BAÑO.

IN.14.535

Cabide triplo /
 Triple Hook /
 Percha tripla.



MATERIAL: EN 1.4301 / AISI 304

ACABAMENTO / FINISH / ACABADO:
STANDARD: SATINADO / SATIN / SATIN

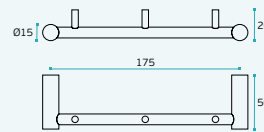

IN.14.505.3

Cabide triplo /
 Triple hook /
 Percha tripla.



MATERIAL: EN 1.4301 / AISI 304

ACABAMENTO / FINISH / ACABADO:
STANDARD: SATINADO / SATIN / SATIN

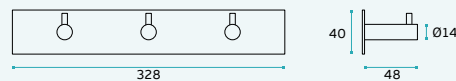

IN.14.506.3

Cabide triplo /
 Triple hook /
 Percha tripla.



MATERIAL: EN 1.4301 / AISI 304

ACABAMENTO / FINISH / ACABADO:
STANDARD: SATINADO / SATIN / SATIN

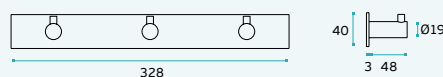

IN.14.500
Cabide / Hook / Percha.



MATERIAL: EN 1.4301 / AISI 304

ACABAMENTO / FINISH / ACABADO:
STANDARD: SATINADO / SATIN / SATIN

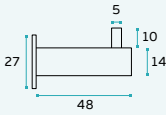

IN.14.501
Cabide / Hook / Percha.



MATERIAL: EN 1.4301 / AISI 304

ACABAMENTO / FINISH / ACABADO:
STANDARD: SATINADO / SATIN / SATIN

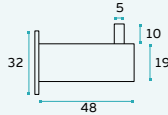

IN.14.505
Cabide / Hook / Percha.



MATERIAL: EN 1.4301 / AISI 304

ACABAMENTO / FINISH / ACABADO:
STANDARD: SATINADO / SATIN / SATIN

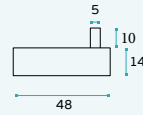

IN.14.506
Cabide / Hook / Percha.



MATERIAL: EN 1.4301 / AISI 304

ACABAMENTO / FINISH / ACABADO:
STANDARD: SATINADO / SATIN / SATIN

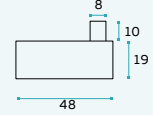

IN.14.536
Cabide /
Hook / Percha.

MATERIAL: EN 1.4301 / AISI 304

ACABAMENTO / FINISH / ACABADO:
STANDARD: SATINADO / SATIN / SATIN

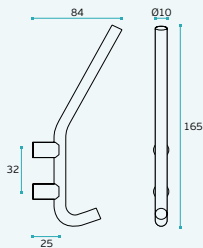

IN.14.528
Cabide /
Hook / Percha.

MATERIAL: EN 1.4301 / AISI 304

ACABAMENTO / FINISH / ACABADO:
STANDARD: SATINADO / SATIN / SATIN

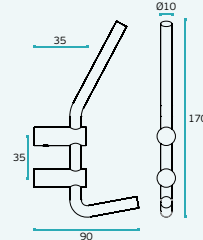

IN.14.538
Cabide /
Hook / Percha.

MATERIAL: EN 1.4301 / AISI 304

ACABAMENTO / FINISH / ACABADO:
STANDARD: SATINADO / SATIN / SATIN

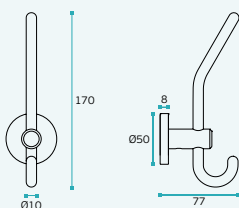

IN.14.539
Cabide /
Hook / Percha.

MATERIAL: EN 1.4301 / AISI 304

ACABAMENTO / FINISH / ACABADO:
STANDARD: SATINADO / SATIN / SATIN

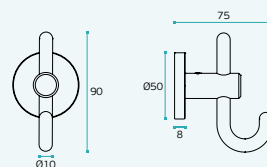

MERIDIAN SERIES

ACESSÓRIOS PARA CASA DE BANHO /
BATHROOM ACCESSORIES /
ACCESORIOS DE BAÑO.





MERIDIAN SERIES

ACESSÓRIOS PARA CASA DE BANHO /
 BATHROOM ACCESSORIES /
 ACCESORIOS DE BAÑO.

MR.46.001. _ _ _

Toalheiro /
 Towel holder / Toallero.
Design: Evol



MATERIAL: EN 1.4301 / AISI 304

ACABAMENTO / FINISH / ACABADO:
STANDARD: SATINADO / SATIN / SATIN

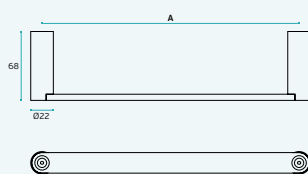

REF	A
MR.46.001.250	250mm
MR.46.001.425	425mm
MR.46.001.600	600mm

MR.46.008

Saboneteira /
 Soap holder / Jabonera.
Design: Evol



MATERIAL: EN 1.4301 / AISI 304

ACABAMENTO / FINISH / ACABADO:
STANDARD: SATINADO / SATIN / SATIN

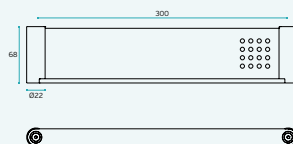

MR.46.003

Estante para toalhas /
 Towel holder /
 Estante toalheiro.
Design: Evol



MATERIAL: EN 1.4301 / AISI 304

ACABAMENTO / FINISH / ACABADO:
STANDARD: SATINADO / SATIN / SATIN

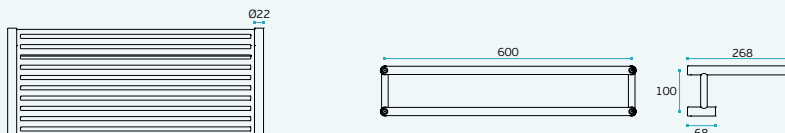

MR.46.004

Porta rolos /
Paper holder /
Soporte de papel.
Design: Evol



MATERIAL: EN 1.4301 / AISI 304

ACABAMENTO / FINISH / ACABADO:
STANDARD: SATINADO / SATIN / SATIN

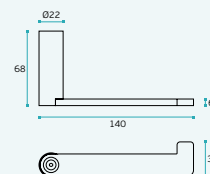

MR.14.006

Cabide /
Hook / Percha.
Design: Evol



MATERIAL: EN 1.4301 / AISI 304

ACABAMENTO / FINISH / ACABADO:
STANDARD: SATINADO / SATIN / SATIN

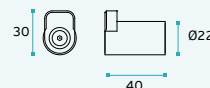

MR.46.007

Porta piaçaba de parede /
Wall toilet brush /
Escobillero de pared.
Design: Evol

MATERIAL: EN 1.4301 / AISI 304

ACABAMENTO / FINISH / ACABADO:
STANDARD: SATINADO / SATIN / SATIN

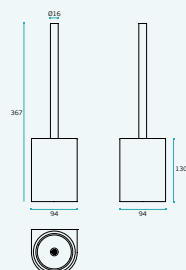

K/1082



Acessórios para casa de banho /
Bathroom accessories /
Accesorios de baño.

Subtil
Series

WWW.JNF.PT

SUBTIL SERIES

ACESSÓRIOS PARA CASA DE BANHO /
BATHROOM ACCESSORIES /
ACCESORIOS DE BAÑO.





SUBTIL SERIES

ACESSÓRIOS PARA CASA DE BANHO /
 BATHROOM ACCESSORIES /
 ACCESORIOS DE BAÑO.

RV.48.006. _ _ _

Toalheiro /
 Towel holder / Toallero.
Design: Rui Viana



MATERIAL: EN 1.4301 / AISI 304
ACABAMENTO / FINISH / ACABADO:
STANDARD: SATINADO / SATIN / SATIN

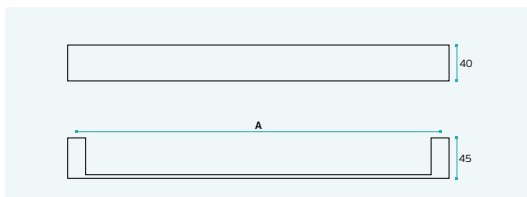

REF	A
RV.48.006.250	250mm
RV.48.006.425	425mm
RV.48.006.600	600mm

RV.48.006.P. _ _ _

Toalheiro /
 Towel holder / Toallero.
Design: Rui Viana



MATERIAL: EN 1.4301 / AISI 304
ACABAMENTO / FINISH / ACABADO:
POLIDO / POLISHED / PULIDO

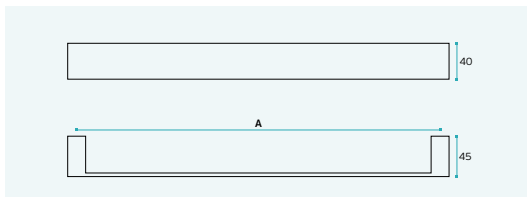

REF	A
RV.48.006.P.250	250mm
RV.48.006.P.425	425mm
RV.48.006.P.600	600mm

RV.48.005

Porta rolo /
 Paper holder /
 Soporte de papel.
Design: Rui Viana



MATERIAL: EN 1.4301 / AISI 304
ACABAMENTO / FINISH / ACABADO:
STANDARD: SATINADO / SATIN / SATIN

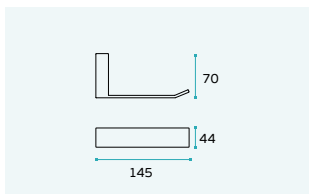

RV.48.005.P

Porta rolo /
 Paper holder /
 Soporte de papel.
Design: Rui Viana



MATERIAL: EN 1.4301 / AISI 304
ACABAMENTO / FINISH / ACABADO:
POLIDO / POLISHED / PULIDO

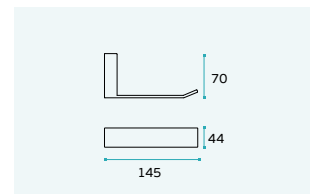



RV.14.002
RV.14.002.P

Cabide /
Hook / Percha.
Design: Rui Viana

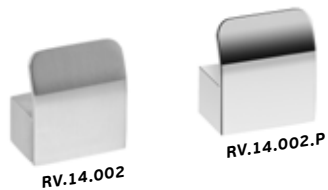

MATERIAL: EN 1.4301 / AISI 304

ACABAMENTO / FINISH / ACABADO:
STANDARD: SATINADO / SATIN / SATIN

ACABAMENTO / FINISH / ACABADO:
POLIDO / POLISHED / PULIDO

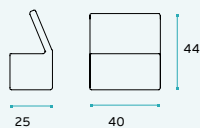

RV.48.003
RV.48.003.P

Porta piaçaba de parede /
Wall toilet brush /
Escobillero de pared.
Design: Rui Viana

MATERIAL: EN 1.4301 / AISI 304

ACABAMENTO / FINISH / ACABADO:
STANDARD: SATINADO / SATIN / SATIN

ACABAMENTO / FINISH / ACABADO:
POLIDO / POLISHED / PULIDO

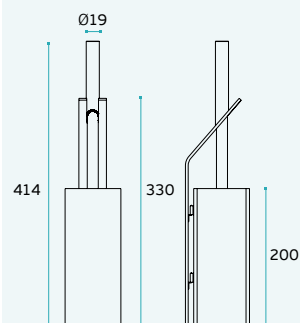

RV.48.001
Saboneteira de parede /
Wall soap holder /
Jabonera de pared.
Design: Rui Viana



MATERIAL: EN 1.4301 / AISI 304

ACABAMENTO / FINISH / ACABADO:
STANDARD: SATINADO / SATIN / SATIN

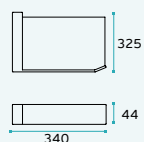

QUADRO SERIES

ACESSÓRIOS PARA CASA DE BANHO /
BATHROOM ACCESSORIES /
ACCESORIOS DE BAÑO.





QUADRO SERIES

ACESSÓRIOS PARA CASA DE BANHO /
 BATHROOM ACCESSORIES /
 ACCESORIOS DE BAÑO.

IN.44.175.---

Toalheiro /
 Towel holder /
 Toallero.



MATERIAL: EN 1.4301 / AISI 304

ACABAMENTO / FINISH / ACABADO:
STANDARD: SATINADO / SATIN / SATIN

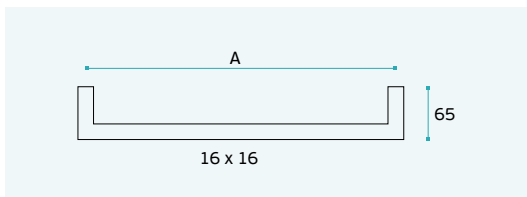

REF	A
IN.44.175.250	250mm
IN.44.175.425	425mm
IN.44.175.600	600mm

.P
 Mirror
 finish

.TB
 PVD
 Titanium
 black

.TG
 PVD
 Titanium
 gold

.TCO
 PVD
 Titanium
 copper

.TCH
 PVD
 Titanium
 chocolate

IN.44.188

Estante para toalhas /
 Towel holder /
 Estante toallero



MATERIAL: EN 1.4301 / AISI 304

ACABAMENTO / FINISH / ACABADO:
STANDARD: SATINADO / SATIN / SATIN

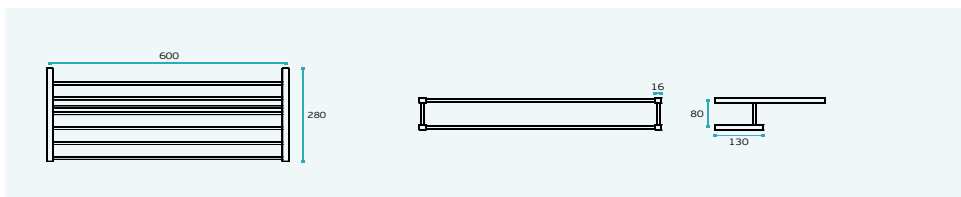

IN.44.179.150

Saboneteira de parede /
 Wall soap holder /
 Jabonera de pared.



MATERIAL: EN 1.4301 / AISI 304

ACABAMENTO / FINISH / ACABADO:
STANDARD: SATINADO / SATIN / SATIN

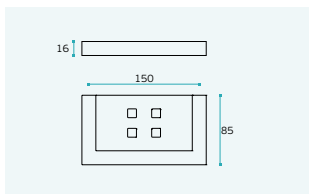

IN.44.179.300

Saboneteira de parede /
 Wall soap holder /
 Jabonera de pared.



MATERIAL: EN 1.4301 / AISI 304

ACABAMENTO / FINISH / ACABADO:
STANDARD: SATINADO / SATIN / SATIN

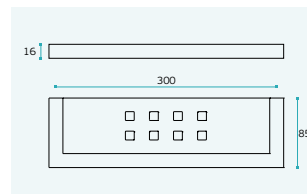



IN.14.601.S
IN.14.601.P
IN.14.601.B
Cabide / Hook / Percha
Design: Christian Magalhães



MATERIAL: ALUMINIO / ALUMINIUM

ACABAMENTO / FINISH / ACABADO:

IN.14.601.S: INOX / STAINLESS STEEL

IN.14.601.P: POLIDO / POLISHED / PULIDO

IN.14.601.B: PRETO MATTE ESCOVADO /
BLACK MATTE / NEGRO MATE SATIN

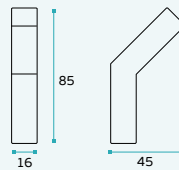

IN.14.177
Cabide /
Hook / Percha.



MATERIAL: EN 1.4301 / AISI 304

ACABAMENTO / FINISH / ACABADO:

STANDARD: SATINADO / SATIN / SATIN



IN.44.176
Porta rolo /
Paper holder / Soporte de papel.



MATERIAL: EN 1.4301 / AISI 304

ACABAMENTO / FINISH / ACABADO:
STANDARD: SATINADO / SATIN / SATIN

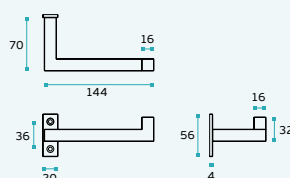

IN.41.191
Saboneteira /
Soap holder / Jabonera



MATERIAL: EN 1.4301 / AISI 304

ACABAMENTO / FINISH / ACABADO:
STANDARD: SATINADO / SATIN / SATIN

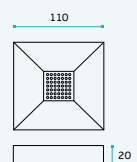

QUADRO SERIES

ACESSÓRIOS PARA CASA DE BANHO /
 BATHROOM ACCESSORIES /
 ACCESORIOS DE BAÑO.

IN.44.190

Porta piaçaba com porta rolo /
 Toilet brush with paper holder /
 Escobillero con soporte de papel.

MATERIAL: EN 1.4301 / AISI 304

ACABAMENTO / FINISH / ACABADO:
STANDARD: SATINADO / SATIN / SATIN

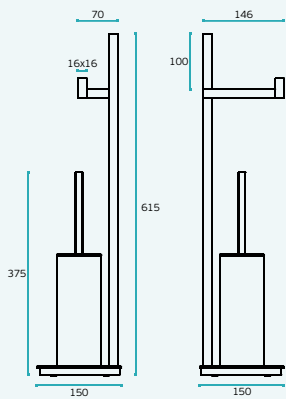

IN.44.190.P

Porta piaçaba com porta rolo /
 Toilet brush with paper holder /
 Escobillero con soporte de papel.

MATERIAL: EN 1.4301 / AISI 304

ACABAMENTO / FINISH / ACABADO:
POLIDO / POLISHED / PULIDO

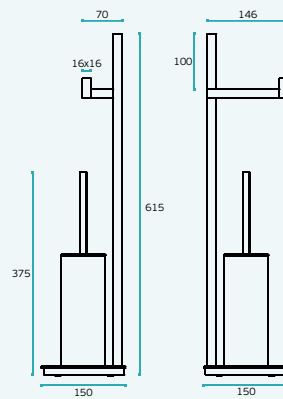

.P
 Mirror
 finish

.TB
 PVD
 Titanium
 black

.TG
 PVD
 Titanium
 gold

.TCO
 PVD
 Titanium
 copper

.TCH
 PVD
 Titanium
 chocolate

IN.44.185

IN.44.185.P

Porta piaçaba /
 Toilet brush / Escobillero

MATERIAL: EN 1.4301 / AISI 304

ACABAMENTO / FINISH / ACABADO:
STANDARD: SATINADO / SATIN / SATIN

OPTIONAL:
 POLIDO / POLISHED / PULIDO

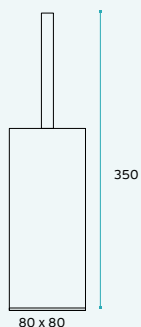

IN.44.186

IN.44.186.P

Porta piaçaba de parede /
 Wall toilet brush /
 Escobillero de pared

MATERIAL: EN 1.4301 / AISI 304

ACABAMENTO / FINISH / ACABADO:
STANDARD: SATINADO / SATIN / SATIN

OPTIONAL:
 POLIDO / POLISHED / PULIDO

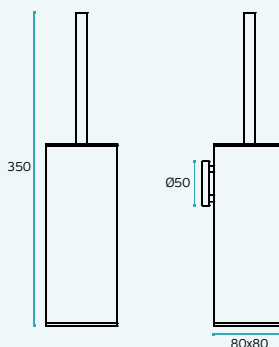

QUADRATO SERIES

ACESSÓRIOS PARA CASA DE BANHO /
BATHROOM ACCESSORIES /
ACCESORIOS DE BAÑO.



QUADRATO SERIES

ACESSÓRIOS PARA CASA DE BANHO /
 BATHROOM ACCESSORIES /
 ACCESORIOS DE BAÑO.

IN.51.001.---

Toalheiro /
 Towel holder /
 Toallero.



MATERIAL: EN 1.4301 / AISI 304

ACABAMENTO / FINISH / ACABADO:
STANDARD: SATINADO / SATIN / SATIN

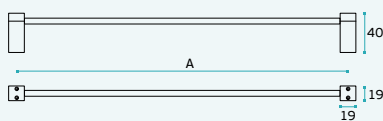

REF	A
IN.51.001.250	250mm
IN.51.001.425	425mm
IN.51.001.600	600mm

.P
 Mirror
 finish

.TB
 PVD
 Titanium
 black

.TG
 PVD
 Titanium
 gold

.TCO
 PVD
 Titanium
 copper

.TCH
 PVD
 Titanium
 chocolate

IN.51.003

Saboneteira de parede /
 Wall soap holder /
 Jabonera de pared.



MATERIAL: EN 1.4301 / AISI 304

ACABAMENTO / FINISH / ACABADO:
STANDARD: SATINADO / SATIN / SATIN

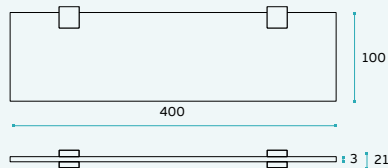

IN.51.004

Saboneteira de canto /
 Wall corner soap holder /
 Jabonera de canto



MATERIAL: EN 1.4301 / AISI 304

ACABAMENTO / FINISH / ACABADO:
STANDARD: SATINADO / SATIN / SATIN

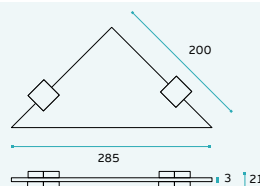



CS.14.004.Q

Cabide /
Hook / Percha

MATERIAL: EN 1.4301 / AISI 304

ACABAMENTO / FINISH / ACABADO:
STANDARD: SATINADO / SATIN / SATIN



IN.14.545

Cabide /
Hook / Percha.

MATERIAL: EN 1.4301 / AISI 304

ACABAMENTO / FINISH / ACABADO:
STANDARD: SATINADO / SATIN / SATIN

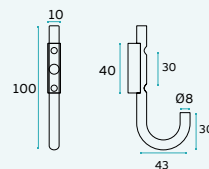

IN.51.002

Porta rolo /
Paper holder / Soporte de papel.

MATERIAL: EN 1.4301 / AISI 304

ACABAMENTO / FINISH / ACABADO:
STANDARD: SATINADO / SATIN / SATIN

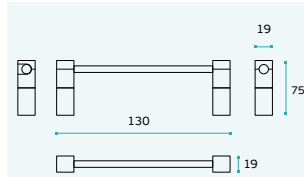

IN.14.544

Cabide /
Hook / Percha.

MATERIAL: EN 1.4301 / AISI 304

ACABAMENTO / FINISH / ACABADO:
STANDARD: SATINADO / SATIN / SATIN

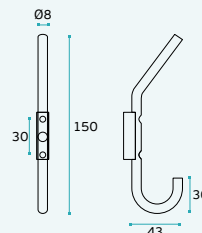

CILINDRO SERIES

ACESSÓRIOS PARA CASA DE BANHO /
BATHROOM ACCESSORIES /
ACCESORIOS DE BAÑO.



IN.52.101. _ _ _

Toalheiro /
Towel holder /
Toallero.



MATERIAL: EN 1.4301 / AISI 304

ACABAMENTO / FINISH / ACABADO:
STANDARD: SATINADO / SATIN / SATIN

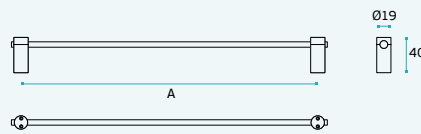

REF	A
IN.52.101.250	250mm
IN.52.101.425	425mm
IN.52.101.600	600mm

CS.47.006

Toalheiro ou cabide /
Towel holder or hook /
Toallero o percha.



MATERIAL: EN 1.4301 / AISI 304

ACABAMENTO / FINISH / ACABADO:
STANDARD: SATINADO / SATIN / SATIN

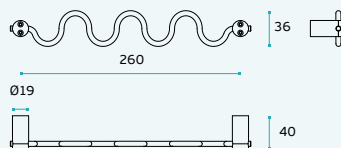

IN.52.102

Porta rolo /
Paper holder /
Soporte de papel.



MATERIAL: EN 1.4301 / AISI 304

ACABAMENTO / FINISH / ACABADO:
STANDARD: SATINADO / SATIN / SATIN

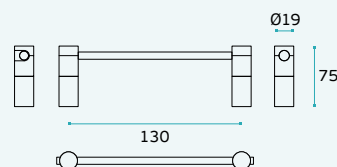

Acessórios com bases (aumento de resistência de fixação à parede) /
Accessories with base (increase of the resistance for wall fixing) /
Accesorios con bases (aumento de resistencia de la fijación a la pared.)

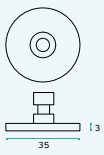

IN.08.BRC.35
 Base para toalheiros /
 Base for towel rack /
 Base para toallero.

Ø19
mm

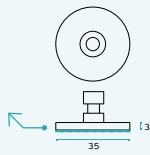

IN.08.BRG.35
 Base de colar para toalheiro /
 Base to glue towel rack /
 Base para pegar toallero.

Ø19
mm

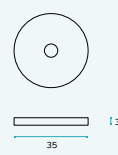

IN.08.BRO.55
 Base para toalheiro /
 Base for towel rack /
 Base para toallero.

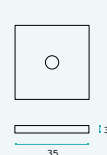
Ø16
mm



IN.08.BQT
 Base para toalheiros /
 Base for towel rack /
 Base para toallero.

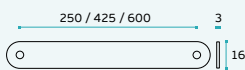

IN.08.BOT.16.250
IN.08.BOT.16.425
IN.08.BOT.16.600
 Base para toalheiro /
 Base for towel rack / Base para toallero.

Ø16
mm

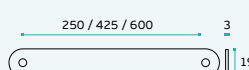

IN.08.BOT.19.250
IN.08.BOT.19.425
IN.08.BOT.19.600
 Base para toalheiro /
 Base for towel rack / Base para toallero.

Ø19
mm

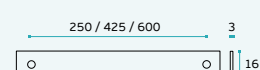

IN.08.BRT.250
IN.08.BRT.425
IN.08.BRT.600
 Base para toalheiro /
 Base for towel rack / Base para toallero.

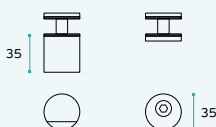

IN.08.TVK.16
 Kit de bases e puxador para porta de chuveiro /
 Kit with bases and handle for the shower door /
 Kit de bases y pomo para puerta de la ducha.

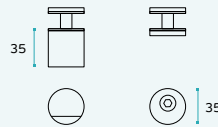

IN.08.TVK.19
 Kit de bases e puxador para porta de chuveiro /
 Kit with bases and handle for the shower door /
 Kit de bases y pomo para puerta de la ducha.



IN.08.TVV.16
IN.08.TVV.19
 Kit de bases para porta de chuveiro /
 Kit with bases for the shower door /
 Kit de bases para puerta de la ducha.

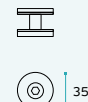



A JNF desenvolveu esta nova linha de acessórios de casa de banho industrial, tendo em especial atenção o funcionamento de todas as peças como um conjunto, embora que, com funções distintas. Existe uma linha condutora que cria uma uniformidade de volumes, não descurando alguns fatores que são fundamentais para o bom funcionamento deste tipo de acessórios /

JNF has developed this new series of industrial bathroom accessories, with particular attention to the set of all components, so that it works as a whole. There is a conductive line that creates a uniformity of volumes, without neglect some factors that are critical to the proper functioning of this type of accessories /

JNF ha desarrollado esta nueva línea de accesorios de baño industriales, con especial atención a la operación de todas las partes en su conjunto, a pesar de que, con funciones distintas. Hay una línea conductora que crea una uniformidad de los volúmenes, sin olvidar algunos factores que son fundamentales para el buen funcionamiento de este tipo de accesorios.

INDUSTRIAL SERIES

ACESSÓRIOS PARA CASA DE BANHO /
BATHROOM ACCESSORIES /
ACCESORIOS DE BAÑO.

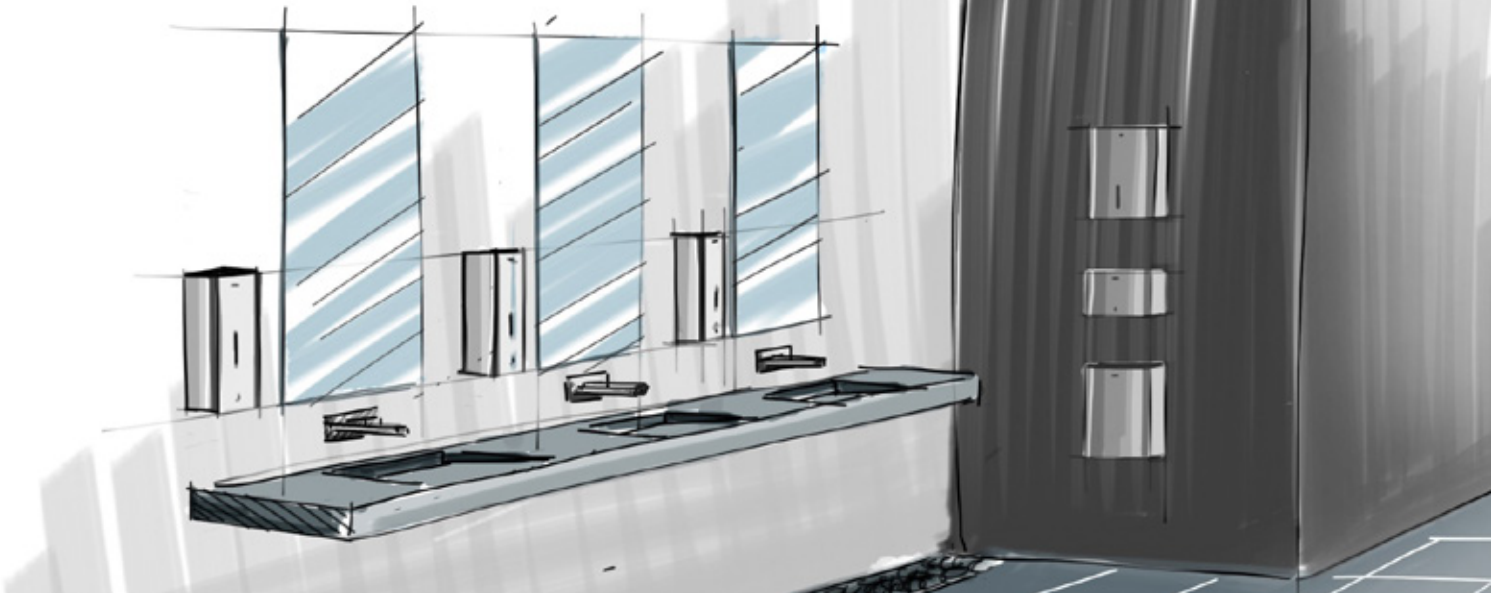

FUNCIONALIDADE

Todas as peças foram desenhadas de forma a serem fácil e intuitivamente operadas por qualquer utilizador.

ERGONOMIA

Aplicando teoria, princípios, dados e métodos de ergonomia, conseguiu-se projetar um conjunto de elementos otimizados para o bem-estar humano e desempenho geral do sistema.

PERFORMANCE

Todos os elementos elétricos e eletrónicos usados garantem uma grande performance de funcionamento e simultaneamente economia de energia, factor de grande importância na redução de custos e impacto ambiental.

LIMPEZA E HIGIENE

O design da estrutura principal de todas as peças teve em grande consideração a limpeza e higiene, criando superfícies grandes e lisas, permitindo a fácil limpeza e desinfeção das peças, características fundamentais em elementos que podem ser manipulados diariamente por milhares de pessoas.

SEGURANÇA

Foi um dos grandes pontos de foco, o desenho ter especial cuidado com as formas não agressivas, algo que foi conseguido com as laterais ligeiramente boleadas, mantendo as formas gerais retangulares.

APOIO A PESSOAS COM MOBILIDADE CONDICIONADA

Ao projetarmos esta série, tivemos sempre presente a aplicabilidade destas peças em casas de banho destinadas a pessoas com mobilidade reduzida, sendo possível a instalação das mesmas em diferentes alturas mantendo a facilidade de utilização dos equipamentos.

INSTALAÇÃO

Ao termos peças que partilham dimensões semelhantes também a forma de instalar e furações para fixar à parede foram mantidas semelhantes, simplificando a instalação e, simultaneamente, permitindo poupar tempo na aplicação.

FUNCTIONALITY

All parts are designed so that they can be easily and intuitively operated by any user.

ERGONOMIA

Applying theory, principles, data and ergonomics methods, it was possible to design a set of optimized elements for human well-being and overall system performance.

PERFORMANCE

All electric and electronic elements used, guarantee an high operating performance and, simultaneously, energy saving. Great importance factor in reducing costs and environmental impact.

CLEANLINESS AND HYGIENE

The main structure design of all parts had in serious consideration the cleanliness and hygiene, creating large, smooth surfaces, allowing an easy cleaning and disinfecting of the parts. Those are fundamental product characteristics because they can be manipulated by thousands of people every day.

SECURITY

Was one of the major focus points, the design take special care with non-aggressive forms, something that has been achieved with the slightly fillets on the side, but maintaining the general rectangular forms.

AIDS FOR DISABLED PEOPLE

When projecting this series, we always had in mind the application in bathrooms for people with reduced mobility, being possible to install them at different heights while maintaining the ease of use of the equipment.

INSTALLATION

These products share similar dimensions, so the installation and drilling templates are also similar, reducing time and simplifying the application.

FUNCIONALIDAD

Todas las piezas están diseñadas de manera que sea fácil e intuitivamente operado por cualquier usuario.

ERGONOMÍA

Aplicando teoría, principios, datos y métodos de ergonomia, hemos sido capaces de diseñar un conjunto de elementos optimizados para el bienestar humano y el rendimiento general del sistema.

RENDIMIENTO

Todos los elementos eléctricos y electrónicos usados garantizar un rendimiento de alto funcionamiento y al mismo tiempo el ahorro de energía, factor muy importante en la reducción de costes y el impacto ambiental.

LIMPIEZA E HIGIENE

El diseño de la estructura principal de todas las partes debe muy en cuenta a la limpieza y la higiene, creando grandes superficies y lisas, lo que permite una fácil limpieza y desinfección de las partes, características fundamentales de los elementos que se pueden ser manipulados por miles de personas diariamente.

SEGURIDAD

Fue uno de los principales puntos de enfoque, el diseño tenga especial cuidado con las formas no agresivas, algo que se ha conseguido con las laterales boleadas, manteniendo las formas rectangulares generales.

APOYO PARA PERSONAS DE MOVILIDAD REDUCIDA

Al proyectar esta serie, siempre se ha pensado en la aplicabilidad de estas piezas en los baños para personas con movilidad reducida, por lo que es posible la instalación de la misma a diferentes alturas, manteniendo la facilidad de uso de los equipos.

INSTALACIÓN

Quando tenemos piezas que comparten dimensiones similares también la forma de instalar y agujeros para fijar a la pared se mantuvieron similares, lo que simplifica la instalación y al mismo tiempo, ahorrando tiempo en la aplicación.

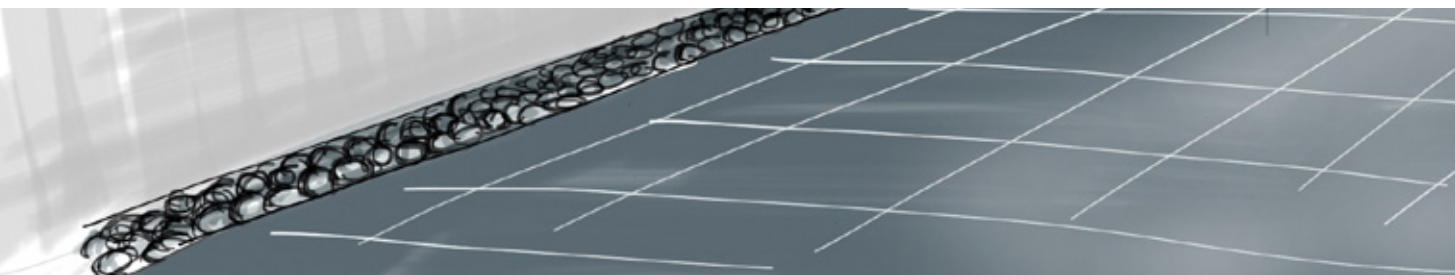



1



1>
IN.60.562
Dispensador de sabão automático /
Automatic liquid soap dispenser /
Dispensador de jabón automático.

IN.60.561
Cesto de papéis de parede /
Wall waste receptacle /
Papeleria de pared.

2

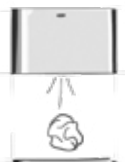

2>
IN.60.548
Dispensador de toalhas de papel /
Tissue paper box /
Dispensador de toallas de papel.

IN.60.566
Secador de mãos automático /
Automatic hand dryer /
Secador de manos automático.

IN.60.561
Cesto de papéis de parede /
Wall waste receptacle /
Papeleria de pared.

3

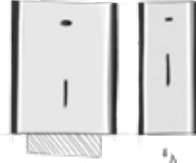

3>
IN.60.548
Dispensador de toalhas de papel /
Tissue paper box /
Dispensador de toallas de papel.

IN.60.562
Dispensador de sabão automático /
Automatic liquid soap dispenser /
Dispensador de jabón automático.

IN.60.561
Cesto de papéis de parede /
Wall waste receptacle /
Papeleria de pared.

4

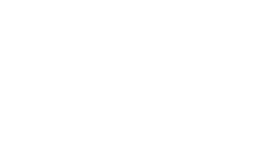
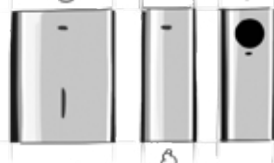

4>
IN.60.561
Cesto de papéis de parede /
Wall waste receptacle /
Papeleria de pared.

IN.60.563
Dispensador de sabão automático /
Automatic liquid soap dispenser /
Dispensador de jabón automático.

IN.60.564
Cesto de papéis de parede /
Wall waste receptacle /
Papeleria de pared.

5

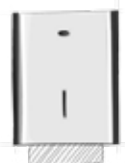

5>
IN.60.561
Cesto de papéis de parede /
Wall waste receptacle /
Papeleria de pared.

IN.60.563
Dispensador de sabão automático /
Automatic liquid soap dispenser /
Dispensador de jabón automático.

IN.60.564
Cesto de papéis de parede /
Wall waste receptacle /
Papeleria de pared.

INDUSTRIAL SERIES

ACESSÓRIOS PARA CASA DE BANHO /
 BATHROOM ACCESSORIES /
 ACCESORIOS DE BAÑO.

IN.60.566

Secador de mãos automático.

Baixo consumo. Dimensões reduzidas.

Desenhado para uso intensivo. Sensor automático infravermelho, auto-ajustável /

Automatic hand dryer. Low consumption. Small dimensions. Designed for intensive use.

Self-adjusting infrared automatic sensor /

Secador de mãos automático.

Bajo consumo. Pequeñas dimensiones.

Diseñado para un uso intensivo. Sensor automático de infrarrojos, autoajustable.

TIPO MOTOR / MOTOR TYPE	500W-2900RPM
VOLTAGEM / VOLTAGE	220/240V; 50/60HZ
TEMPERATURA SAÍDA DO AR / AIR OUTPUT TEMPERATURE	50°C (131°F)
VELOCIDADE AR / AIR SPEED	90M/S
TEMPO SECAGEM / DRYING TIME	10-15 S
ISOLAMENTO / ISOLATION	CLASS 1

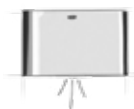

MATERIAL: EN 1.4301 / AISI 304

FINISH : SATINADO / SATIN / SATIN

OPTIONAL: PVD TITANIUM COATED

.TB / .TG / .TCO / .TCH

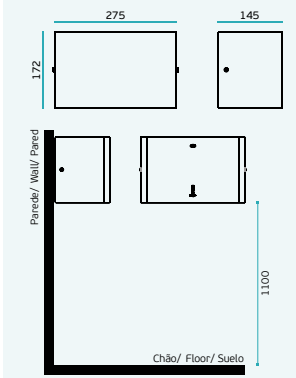

IN.60.548

Dispensador de toalhas de papel /

Tissue paper box /

Dispensador de toallas de papel.



MATERIAL: EN 1.4301 / AISI 304

ACABAMENTO / FINISH / ACABADO:
STANDARD: SATINADO / SATIN / SATIN

OPTIONAL: PVD TITANIUM COATED

.TB / .TG / .TCO / .TCH

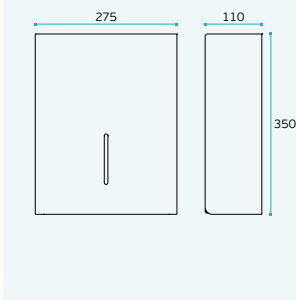

IN.60.565

Dispensador de rolo JUMBO /

JUMBO roll tissue dispenser /

Dispensador de papel JUMBO.

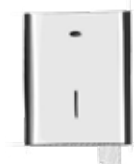

MATERIAL: EN 1.4301 / AISI 304

ACABAMENTO / FINISH / ACABADO:
STANDARD: SATINADO / SATIN / SATIN

OPTIONAL: PVD TITANIUM COATED

.TB / .TG / .TCO / .TCH

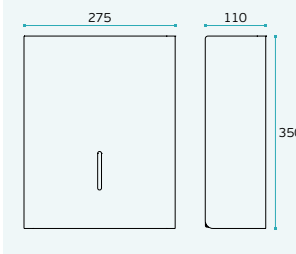

.P
Mirror
finish

.TB
PVD
Titanium
black

.TG
PVD
Titanium
gold

.TCO
PVD
Titanium
copper

.TCH
PVD
Titanium
chocolate

IN.60.561
Cesto de papéis de parede /
Wall waste receptacle /
Papelera de pared.



MATERIAL: EN 1.4301 / AISI 304

ACABAMENTO / FINISH / ACABADO:
STANDARD: SATINADO / SATIN / SATIN

OPTIONAL: PVD TITANIUM COATED

.TB / .TG / .TCO / .TCH

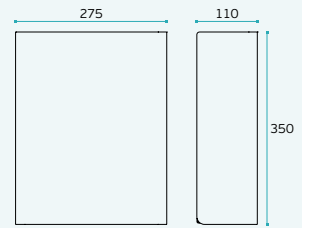

NEW

IN.60.568
Cesto de papéis de parede /
Wall waste receptacle /
Papelera de pared.



MATERIAL: EN 1.4301 / AISI 304

ACABAMENTO / FINISH / ACABADO:
STANDARD: SATINADO / SATIN / SATIN

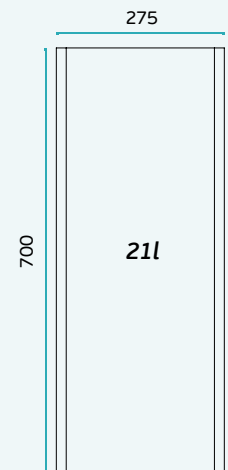

INDUSTRIAL SERIES

ACESSÓRIOS PARA CASA DE BANHO /
 BATHROOM ACCESSORIES /
 ACCESORIOS DE BAÑO.

IN.60.562

Dispensador de sabão automático.
Reservatório plástico com 900cc.
Duração das baterias 25000 ciclos ou 1 ano.
Dose de sabão: 0,7-0,8CC (adequado para álcool gel, álcool líquido, sabonete líquido, desinfetantes para as mãos, iodo esterilizado e detergentes)
Fácil manutenção /

Automatic liquid soap dispenser. Plastic container with 900cc. Battery life 25,000 cycles or 1 year
 Foam dose: 0.7 - 0,8CC. Easy maintenance /

Dispensador de jabón automático. Recipiente de plástico con 900cc. Duración de la batería 25.000 ciclos o 1 año. Dosis de espuma: 0,7 - 0,8CC. Fácil mantenimiento.



MATERIAL: EN 1.4301 / AISI 304

ACABAMENTO / FINISH / ACABADO:
STANDARD: SATINADO / SATIN / SATIN

OPTIONAL: PVD TITANIUM COATED

.TB / .TG / .TCO / .TCH

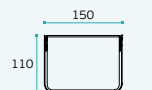

.P
 Mirror finish

.TB
 PVD
 Titanium black

.TG
 PVD
 Titanium gold

.TCO
 PVD
 Titanium copper

.TCH
 PVD
 Titanium chocolate

IN.60.563

Dispensador de sabão em espuma automático.
Reservatório plástico com 900cc
Duração das baterias 25000 ciclos ou 1 ano
Dose de espuma: 0,7 - 0,8CC
Fácil manutenção /

Automatic soap in foam dispenser
 Plastic container with 900cc
 Battery life 25,000 cycles or 1 year
 Foam dose: 0.7 - 0,8CC
 Easy maintenance /

Dispensador de jabón en espuma automático.
 Recipiente de plástico con 900cc
 Duración de la batería 25.000 ciclos o 1 año
 Dosis de espuma: 0,7 - 0,8CC
 Fácil mantenimiento.



MATERIAL: EN 1.4301 / AISI 304

ACABAMENTO / FINISH / ACABADO:
STANDARD: SATINADO / SATIN / SATIN

OPTIONAL: PVD TITANIUM COATED

.TB / .TG / .TCO / .TCH

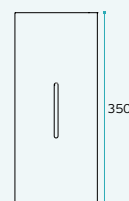
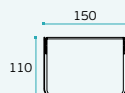

IN.60.564

Cesto de papéis de parede /
Wall waste receptacle /
Papelera de pared.



2,5L



MATERIAL: EN 1.4301 / AISI 304

ACABAMENTO / FINISH / ACABADO:
STANDARD: SATINADO / SATIN / SATIN

OPTIONAL: PVD TITANIUM COATED

.TB / .TG / .TCO / .TCH

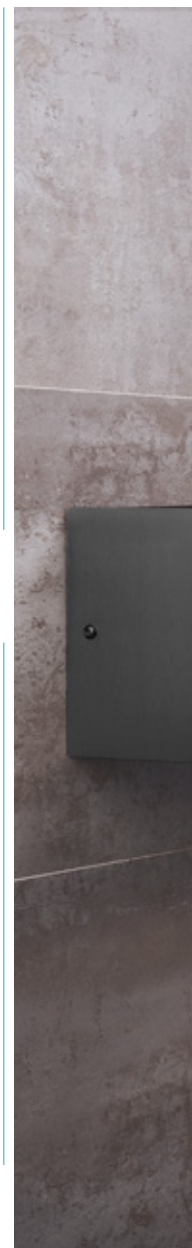
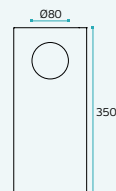
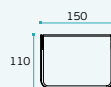

.P
Mirror
finish

IN.60.567
Cesto de papéis de parede /
Wall waste receptacle /
Papelera de pared.

.TB .TG .TCO .TCH

3,5L



MATERIAL: EN 1.4301 / AISI 304

ACABAMENTO / FINISH / ACABADO:
STANDARD: SATINADO / SATIN / SATIN

OPTIONAL: PVD TITANIUM COATED

.TB / .TG / .TCO / .TCH

.TB
PVD
Titanium
black

.TG
PVD
Titanium
gold

.TCO
PVD
Titanium
copper

.TCH
PVD
Titanium
chocolate

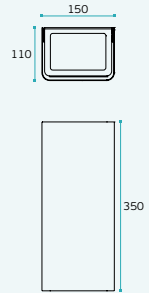

INDUSTRIAL SERIES

ACESSÓRIOS PARA CASA DE BANHO /
BATHROOM ACCESSORIES /
ACCESORIOS DE BAÑO.





INDUSTRIAL SERIES

ACESSÓRIOS PARA CASA DE BANHO /
 BATHROOM ACCESSORIES /
 ACCESORIOS DE BAÑO.

IN.60.657

Dispensador de rolo JUMBO com painéis laterais em resina fenólica /

JUMBO roll tissue dispenser with phenolic resin side panels /
 Dispensador de papel JUMBO con paneles laterales en resina fenólica.



MATERIAL: EN 1.4301 / AISI 304

ACABAMENTO / FINISH / ACABADO:
STANDARD: SATINADO / SATIN / SATIN

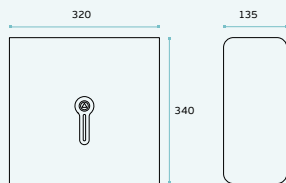

MATERIAL: EN 1.4301 / AISI 304

ACABAMENTO / FINISH / ACABADO:
STANDARD: SATINADO / SATIN / SATIN

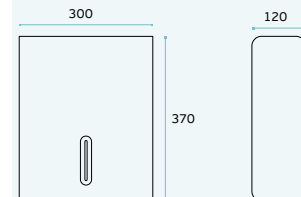

.P
 Mirror
 finish

.TB
 PVD
 Titanium
 black

.TG
 PVD
 Titanium
 gold

.TCO
 PVD
 Titanium
 copper

.TCH
 PVD
 Titanium
 chocolate

IN.60.659

Cesto de papéis de parede com painéis laterais em resina fenólica e com balde interior amovível /

Wall paper bin with side panels in phenolic resin /
 Cesto de papel de pared con paneles laterales en resina fenólica.

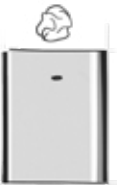

MATERIAL: EN 1.4301 / AISI 304

ACABAMENTO / FINISH / ACABADO:
STANDARD: SATINADO / SATIN / SATIN

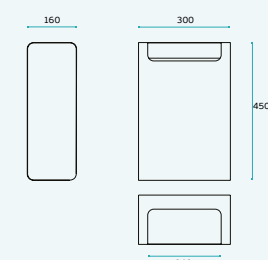

IN.60.660

Dispensador de sabão líquido automático com painéis laterais em resina fenólica /

Automatic soap dispenser with side panels in phenolic resin /
 Dispensador de jabón líquido automático con paneles laterales en resina fenólica.



MATERIAL: EN 1.4301 / AISI 304

ACABAMENTO / FINISH / ACABADO:
STANDARD: SATINADO / SATIN / SATIN

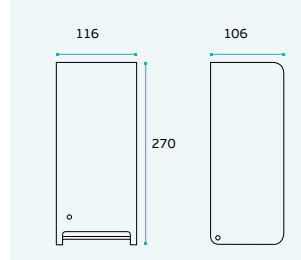

.P
Mirror
finish

.TB
PVD
Titanium
black

.TG
PVD
Titanium
gold

.TCO
PVD
Titanium
copper

.TCH
PVD
Titanium
chocolate

IN.60.554

Secador de mãos automático com painéis laterais em resina fenólica.
Uso intensivo /

Automatic hand dryer with side panels in phenolic resin. Intensive use /
Secador de mãos automático com painéis laterais em resina fenólica.
Uso intensivo.



MATERIAL: EN 1.4301 / AISI 304

ACABAMENTO / FINISH / ACABADO:
STANDARD: SATINADO / SATIN / SATIN

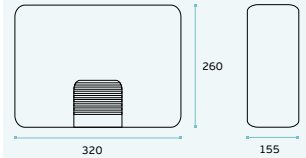

IN.60.656

Dispensador de toalhas com cesto para papéis. Aço inox com painéis laterais em resina fenólica /

Wall towel dispenser with waste receptacle. Stainless steel cover with side panels in phenolic resin /

Dispensador de toallas de pared con papelera en acero inoxidable con paneles laterales en resina fenólica.



MATERIAL: EN 1.4301 / AISI 304

ACABAMENTO / FINISH / ACABADO:
STANDARD: SATINADO / SATIN / SATIN

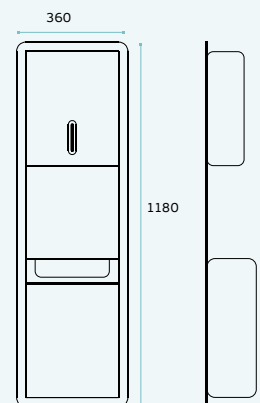

INDUSTRIAL SERIES

ACESSÓRIOS PARA CASA DE BANHO /
BATHROOM ACCESSORIES /
ACCESORIOS DE BAÑO.



IN.60.549

Secador de mãos automático.
Usa intensivo/ Automatic hand
dryer. Intensive use / Secador de
manos automático. Uso intensivo.

TIPO MOTOR / MOTOR TYPE	350-700W
NÍVEL RUÍDO / NOISE LEVEL	77-79DB
VELOCIDADE AR/ AIR SPEED	75-100M/S
SENSOR / SENSOR RANGE	170MM ±20MM
ISOLAMENTO / ISOLATION	CLASS 1



MATERIAL: EN 1.4301 / AISI 304

ACABAMENTO / FINISH / ACABADO:
STANDARD: SATINADO / SATIN / SATIN

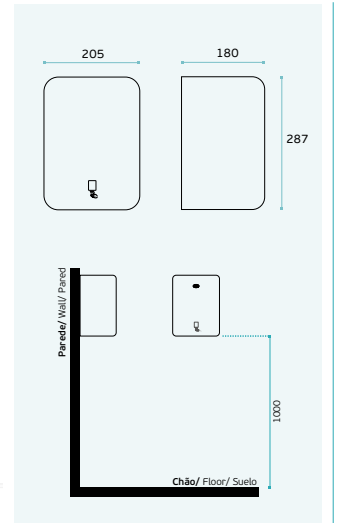

IN.60.546

Secador de mãos automático/
Automatic hand dryer/
Secador de manos automático.

TIPO MOTOR / MOTOR TYPE	1800W-2680RPM
POTÊNCIA MOTOR / MOTOR POWER	60W
NÍVEL RUÍDO / NOISE LEVEL	67DB
VELOCIDADE AR/ AIR SPEED	12M/S
SENSOR / SENSOR RANGE	50MM / 200MM
ISOLAMENTO / ISOLATION	CLASS 1



MATERIAL: EN 1.4301 / AISI 304

ACABAMENTO / FINISH / ACABADO:
STANDARD: SATINADO / SATIN / SATIN

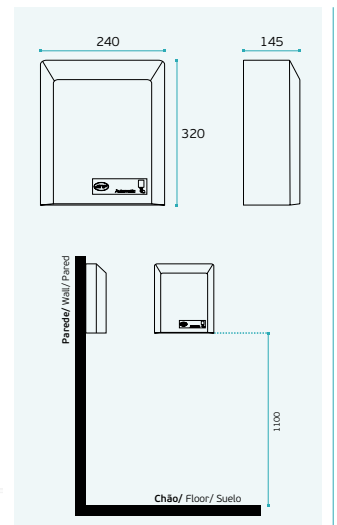
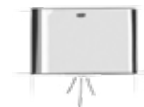

IN.60.550

Dispensador de sabão automático.
Reservatório plástico com 900cc.
Duração das baterias 25000 ciclos ou 1 ano.
Dose de sabão: 0,7-0,8CC (adequado para
álcool gel, álcool líquido, sabonete líquido,
desinfetantes para as mãos, iodo esterilizado
e detergentes) Fácil manutenção /

Automatic liquid soap dispenser. Plastic container
with 900cc. Battery life 25,000 cycles or 1 year
Foam dose: 0.7 - 0,8CC. Easy maintenance /

Dispensador de jabón automático. Recipiente
de plástico con 900cc. Duración de la batería
25.000 ciclos o 1 año. Dosis de espuma: 0,7 -
0,8CC. Fácil mantenimiento.

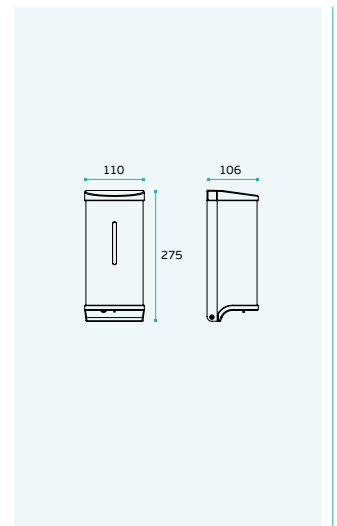

INDUSTRIAL SERIES

ACESSÓRIOS PARA CASA DE BANHO /
 BATHROOM ACCESSORIES /
 ACCESORIOS DE BAÑO.

IN.60.483.05

Dispensador de sabão líquido /
 Soap dispenser /
 Dispensador de jabón líquido.

MATERIAL: EN 1.4301 / AISI 304

ACABAMENTO / FINISH / ACABADO:
 STANDARD: SATINADO / SATIN / SATIN

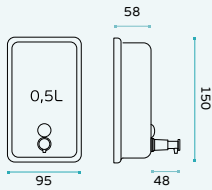

IN.60.483.10

Dispensador de sabão líquido /
 Soap dispenser /
 Dispensador de jabón líquido.

IN.60.483.10: EN 1.4301 / AISI 304
 IN.60.483.10.316: EN 1.4401 / AISI 316

ACABAMENTO / FINISH / ACABADO:
 STANDARD: SATINADO / SATIN / SATIN

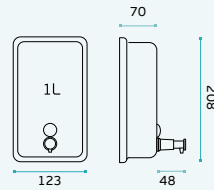

.P
 Mirror
 finish

.TB
 PVD
 Titanium
 black

.TG
 PVD
 Titanium
 gold

.TCO
 PVD
 Titanium
 copper

.TCH
 PVD
 Titanium
 chocolate

IN.60.483.05.P

Dispensador de sabão líquido /
 Soap dispenser /
 Dispensador de jabón líquido.

MATERIAL: EN 1.4301 / AISI 304

ACABAMENTO / FINISH / ACABADO:
 STANDARD: POLIDO / POLISHED / PULIDO

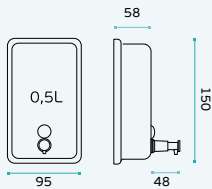

IN.60.483.10.P

Dispensador de sabão líquido /
 Soap dispenser /
 Dispensador de jabón líquido.

IN.60.483.10: EN 1.4301 / AISI 304
 IN.60.483.10.316: EN 1.4401 / AISI 316

ACABAMENTO / FINISH / ACABADO:
 STANDARD: POLIDO / POLISHED / PULIDO

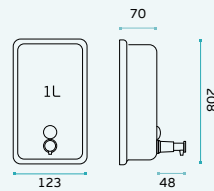

IN.60.544

Dispensador de sabão líquido
 encastrável / Embebed soap
 dispenser / Dispensador de jabón
 líquido encastrable.

MATERIAL:
 EN 1.4301 / AISI 304

ACABAMENTO / FINISH / ACABADO:
 SATINADO / SATIN

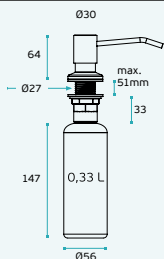

IN.60.545

Dispensador de sabão líquido
 encastrável / Embebed soap
 dispenser / Dispensador de jabón
 líquido encastrable.

MATERIAL:
 EN 1.4301 / AISI 304

ACABAMENTO / FINISH / ACABADO:
 SATINADO / SATIN

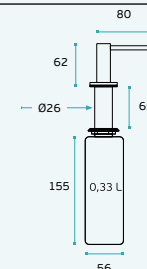

.P
Mirror
finish

.TB
PVD
Titanium
black

.TG
PVD
Titanium
gold

.TCO
PVD
Titanium
copper

.TCH
PVD
Titanium
chocolate

IN.43.485.S

Dispensador de sabão de parede /
Wall soap dispenser /
Dispensador de jabón de pared

MATERIAL: EN 1.4301 / AISI 304

ACABAMENTO / FINISH / ACABADO:
SATINADO / SATIN / SATIN

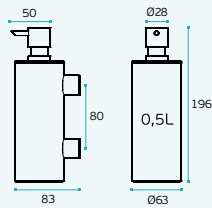

IN.43.486.S

Dispensador de sabão /
Soap dispenser /
Dispensador de jabón.

MATERIAL: EN 1.4301 / AISI 304

ACABAMENTO / FINISH / ACABADO:
SATINADO / SATIN / SATIN

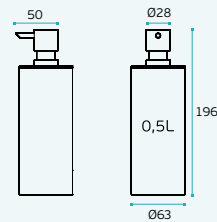

IN.43.485.P

Dispensador de sabão de parede /
Wall soap dispenser /
Dispensador de jabón de pared

MATERIAL: EN 1.4301 / AISI 304

ACABAMENTO / FINISH / ACABADO:
POLIDO / POLISHED/ PULIDO

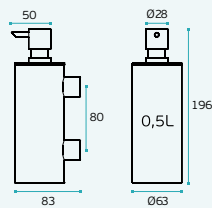

IN.43.486.P

Dispensador de sabão /
Soap dispenser /
Dispensador de jabón.

MATERIAL: EN 1.4301 / AISI 304

ACABAMENTO / FINISH / ACABADO:
POLIDO / POLISHED/ PULIDO

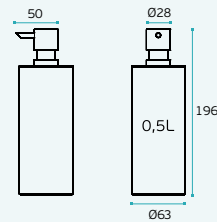

IN.60.551.E / IN.60.551.E.P

Dispensador de toalhas de papel de embutir /
Recessed tissue paper box /
Dispensador de toallas de papel de embutir.

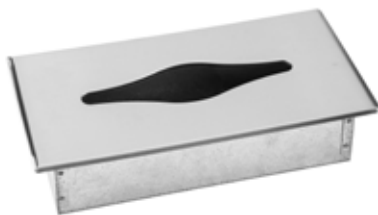

MATERIAL: EN 1.4301 / AISI 304

ACABAMENTO / FINISH / ACABADO:
STANDARD: SATINADO / SATIN / SATIN

MATERIAL: EN 1.4301 / AISI 304

ACABAMENTO / FINISH / ACABADO:
POLIDO / POLISHED/ PULIDO

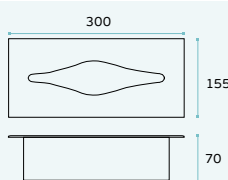

IN.60.551

Dispensador de toalhas de papel de bancada /
Table tissue paper box /
Dispensador de toallas de papel de bancada.



MATERIAL: EN 1.4301 / AISI 304

ACABAMENTO / FINISH / ACABADO:
STANDARD: SATINADO / SATIN / SATIN

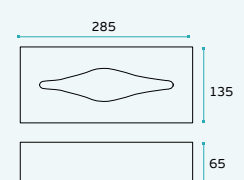

INDUSTRIAL SERIES

ACESSÓRIOS PARA CASA DE BANHO /
 BATHROOM ACCESSORIES /
 ACCESORIOS DE BAÑO.

IN.60.556
Dispensador de
toalhas de papel /
 Tissue paper box /
 Dispensador de toallas
 de papel.



MATERIAL: EN 1.4301 / AISI 304

ACABAMENTO / FINISH / ACABADO: STANDARD: SATINADO / SATIN / SATIN

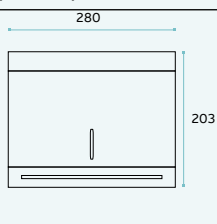

102

IN.60.555
Dispensador de
toalhas de papel /
 Tissue paper box /
 Dispensador de toallas
 de papel.



MATERIAL: EN 1.4301 / AISI 304

ACABAMENTO / FINISH / ACABADO: STANDARD: SATINADO / SATIN / SATIN

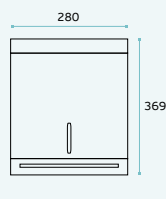

102

IN.60.489
Dispensador de papel
JUMBO / JUMBO
 roll tissue dispenser /
 Dispensador de papel
 JUMBO.



MATERIAL: EN 1.4301 / AISI 304

ACABAMENTO / FINISH / ACABADO: STANDARD: SATINADO / SATIN / SATIN

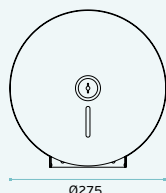

275



115

IN.60.559
Cesto de papéis de
parede / Wall waste
 receptacle /
 Papelera de pared.



MATERIAL: EN 1.4301 / AISI 304

ACABAMENTO / FINISH / ACABADO: STANDARD: SATINADO / SATIN / SATIN

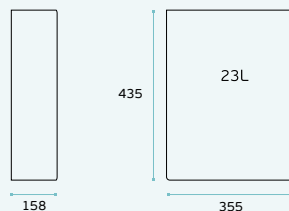

158

435

23L

355

IN.60.557

Conjunto de embutir com dispensador de toalhas e cesto de papéis removível / Recessed set with paper towel dispenser and removable waste receptacle / Unidad para embutir con dispensador de toallas e papellero desprendible.



MATERIAL: EN 1.4301 / AISI 304

ACABAMENTO / FINISH / ACABADO: STANDARD: SATINADO / SATIN / SATIN

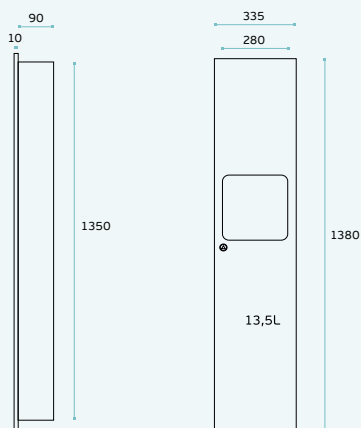

IN.60.558

Conjunto de embutir com dispensador de toalhas e cesto de papéis removível / Recessed set with paper towel dispenser and removable waste receptacle / Unidad para embutir con dispensador de toallas e papellero desprendible.



MATERIAL: EN 1.4301 / AISI 304

ACABAMENTO / FINISH / ACABADO: STANDARD: SATINADO / SATIN / SATIN

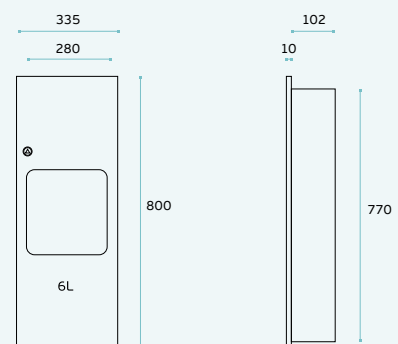

K/1114

JNF ARCHITECTURAL
HARDWARE

Auxílios para pessoas com mobilidade condicionada /
Aids for disabled people /
Ayudas para minusválidos.

Banco para casa de banho /
Bathroom seat /
Asiento para baño.

WWW.JNF.PT

AUXÍLIOS PARA PESSOAS COM MOBILIDADE CONDICIONADA / AIDS FOR DISABLED PEOPLE / AYUDAS PARA MINUSVÁLIDOS.



NEW

IN.12.006

Barra de apoio rebatível /

Folding safety support /

Barra de apoio rebatible.

MATERIAL: EN 1.4372 / AISI 201

STANDARD FINISH: SATINADO / SATIN / SATIN

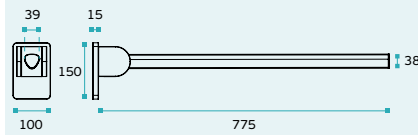

IN.12.006.C

Cobertura para ocultar fixações /

Cover to hide fixings /

Cobertura para ocultar fijaciones.

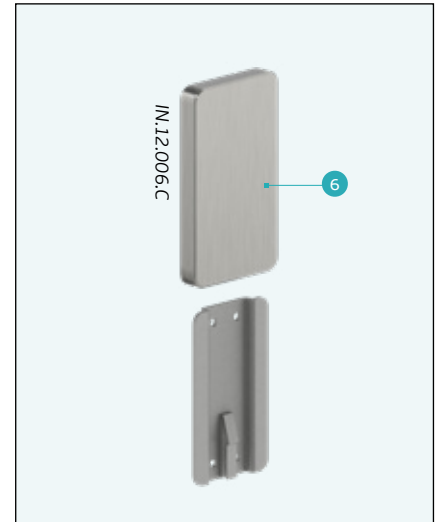
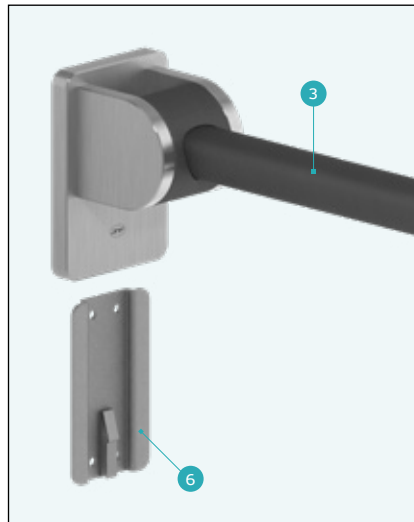
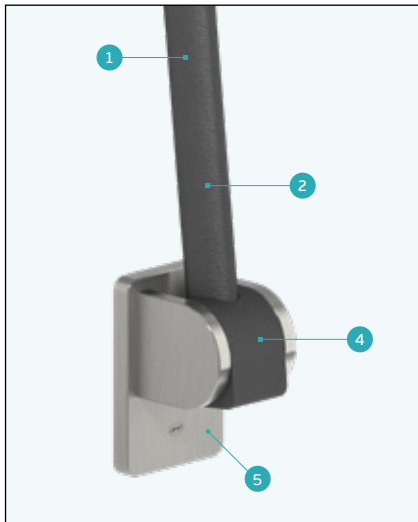

Auxílios para pessoas com mobilidade condicionada /

Aids for disabled people / Ayudas para minusválidos.

1 - Desenho ergonómico com arestas arredondadas.
2 - Barra produzido em material facilmente higienizável, texturado e antiderrapante.
3 - Grande capacidade de carga, peso até 120 Kg.
4 - Sistema retráctil, garante economia de espaço e segurança. Abertura controlado por amortecedor, permitindo um fecho e abertura suave.
5 - Base de fixação à parede robusta, produzida em aço inoxidável EN 1.4103
6 - EASY REMOVE Sistema versátil que permite retirar a barra da parede no caso de não ser necessário, deixando a fixação oculta por uma tampa discreta.

1 - Ergonomic design with rounded edges.
2 - Bar made of easily hygienizable, textured and non-slip material.
3 - Large load capacity, weight up to 120 kg.
4 - Retractable system, guarantees economy of space and security. Damper-controlled system, allowing a soft closing and opening movement.
5 - Sturdy wall mounting base made of stainless steel EN 1.4103.
6 - EASY REMOVE Versatile system that allows you to remove the bar from the wall in case it is not necessary, leaving the attachment hidden base covered.

1 - Diseño ergonómico con aristas redondeadas.
2 - Barra fabricado en material fácilmente higienizado, texturado y antideslizante.
3 - Gran capacidad de carga, peso hasta 120 Kg.
4 - Sistema retráctil, garantiza ahorro de espacio y seguridad. Apertura controlada por amortiguador, permitiendo un cierre y apertura suave.
5 - Base de fijación a la pared robusta, producida en acero inoxidable EN 1.4103
6 - EASY REMOVE Sistema versátil que permite retirar la barra de la pared en caso de no ser necesario, dejando la fijación oculta por una tapa discreta..

AUXÍLIOS PARA PESSOAS COM MOBILIDADE CONDICIONADA / AIDS FOR DISABLED PEOPLE / AYUDAS PARA MINUSVÁLIDOS.

IN.12.039

Banco para WC /
 Bathroom seat /
 Asiento para baño.

MATERIAL: EN 1.4372 / AISI 201

STANDARD FINISH: SATINADO / SATIN / SATIN

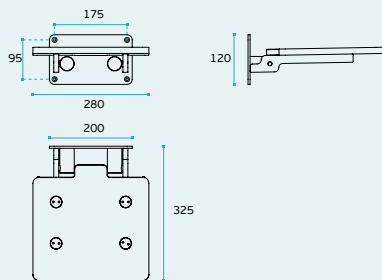

IN.12.044

Banco para WC (Base em resina fenólica) /
 Bathroom seat (Phenolic resin base) /
 Asiento para baño (Base en resina fenolica).

MATERIAL: EN 1.4301 / AISI 304

STANDARD FINISH: SATINADO / SATIN / SATIN

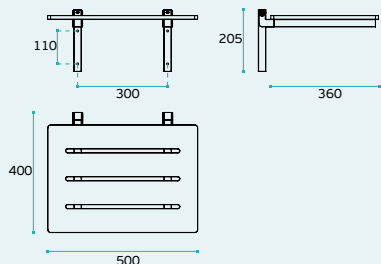

IN.12.045

Banco para WC (Base em resina fenólica) /
 Bathroom seat (Phenolic resin base) /
 Asiento para baño (Base en resina fenolica).



MATERIAL: EN 1.4372 / AISI 201

STANDARD FINISH: SATINADO / SATIN / SATIN

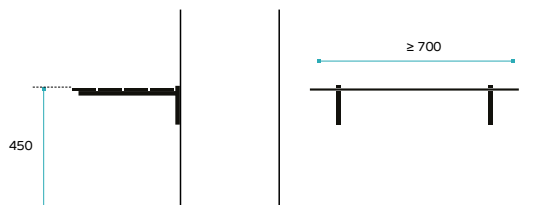
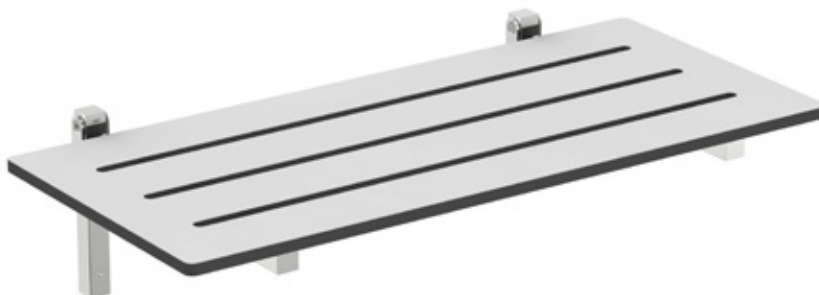
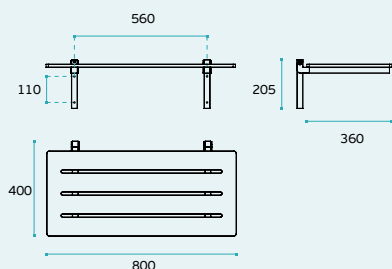

NEW

IN.12.007

Banco para WC /
Bathroom seat /
Asiento para baño..

MATERIAL: EN 1.4301 / AISI 304

STANDARD FINISH: SATINADO / SATIN / SATIN

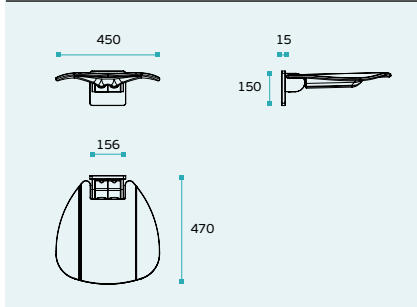

IN.12.007.C

Cobertura para ocultar fixações /
Cover to hide fixings /
Cobertura para ocultar fijaciones.

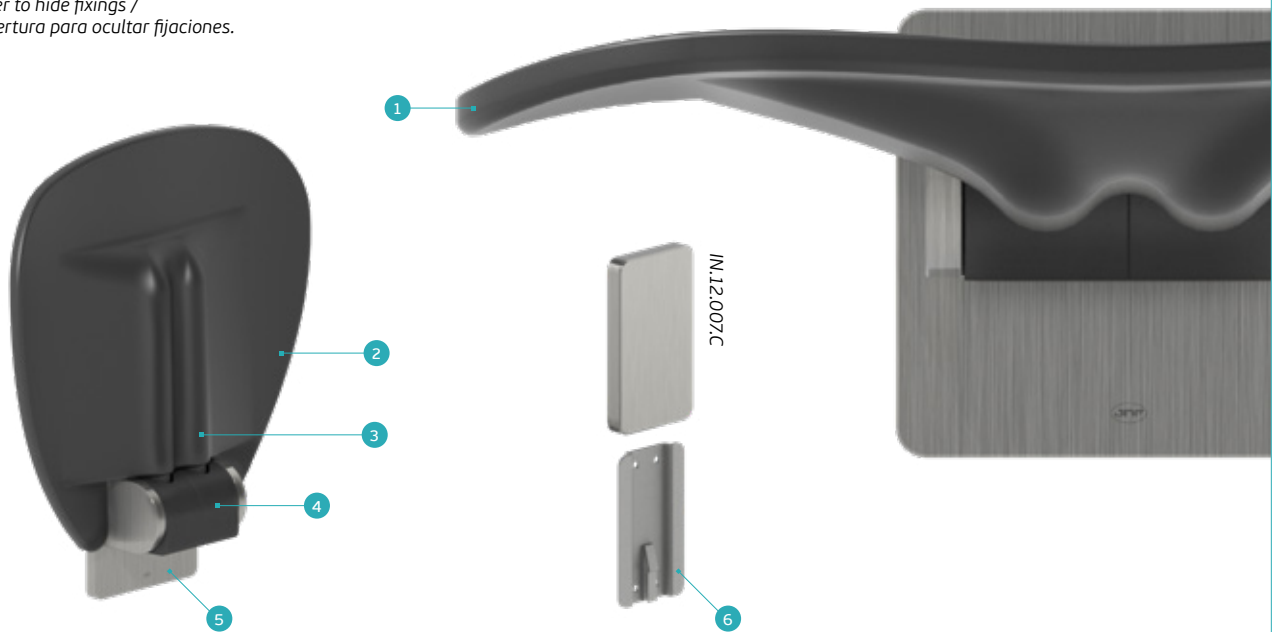

1 - Desenho ergonómico com arestas arredondadas.
2 - Tampo produzido em material facilmente higienizável, texturado e antiderrapante.
3 - Grande capacidade de carga, peso até 150 Kg.
4 - Sistema retráctil, garante economia de espaço e segurança. Abertura controlado por amortecedor, permitindo um fecho e abertura suave.
5 - Base de fixação à parede robusta, produzida em aço inoxidável EN 1.4103
6 - EASY REMOVE Sistema versátil que permite retirar o banco da parede no caso de não ser necessário, deixando a fixação oculta por uma tampa discreta.

1 - Ergonomic design with rounded edges.
2 - Seat made of easily hygienizable, textured and non-slip material.
3 - Large load capacity, weight up to 150 kg.
4 - Retractable system, guarantees economy of space and security. Damper-controlled system, allowing a soft closing and opening movement.
5 - Sturdy wall mounting base made of stainless steel EN 1.4103.
6 - EASY REMOVE Versatile system that allows you to remove the seat from the wall in case it is not necessary, leaving the attachment hidden base covered.

1 - Diseño ergonómico con aristas redondeadas.
2 - Tablero fabricado en material fácilmente higienizado, texturado y antideslizante.
3 - Gran capacidad de carga, peso hasta 150 Kg.
4 - Sistema retráctil, garantiza ahorro de espacio y seguridad. Apertura controlada por amortiguador, permitiendo un cierre y apertura suave.
5 - Base de fijación a la pared robusta, producida en acero inoxidable EN 1.4103
6 - EASY REMOVE Sistema versátil que permite retirar el asiento de la pared en caso de no ser necesario, dejando la fijación oculta por una tapa discreta..

AUXÍLIOS PARA PESSOAS COM MOBILIDADE CONDICIONADA / AIDS FOR DISABLED PEOPLE / AYUDAS PARA MINUSVÁLIDOS.

IN.12.002

Barra de apoio rebatível com porta rolo /

Folding safety support with paper holder /

Barra de apoyo rebatible con soporte de papel.

MATERIAL: EN 1.4372 / AISI 201

STANDARD FINISH: SATINADO / SATIN / SATIN

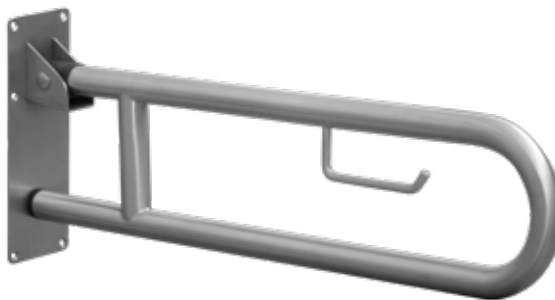
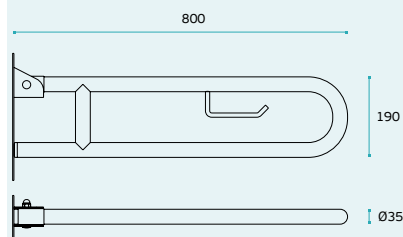

IN.12.022

Barra de apoio rebatível /

Folding safety support /

Barra de apoyo rebatible.

MATERIAL: EN 1.4301 / AISI 304

STANDARD FINISH: SATINADO / SATIN / SATIN

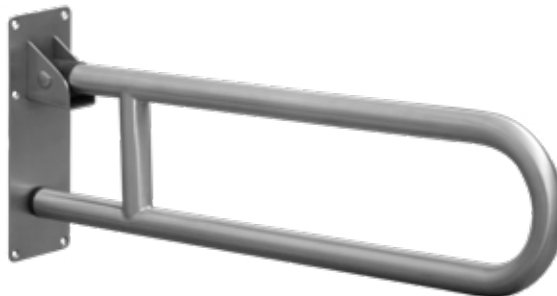
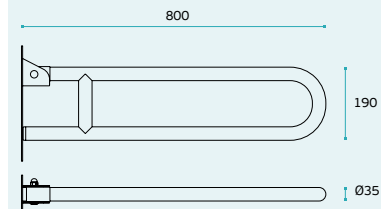

IN.12.003.D

IN.12.003.E

Barra de apoio /

Safety support /

Barra de apoyo.

MATERIAL: EN 1.4301 / AISI 304

STANDARD FINISH: SATINADO / SATIN / SATIN

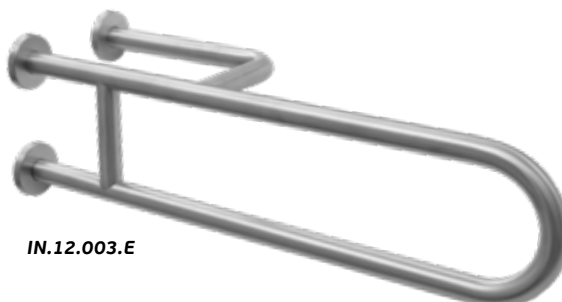
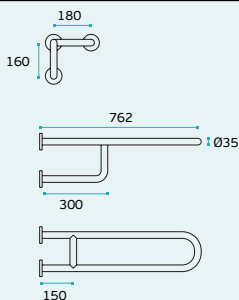

IN.12.003.E



AUXÍLIOS PARA PESSOAS COM MOBILIDADE CONDICIONADA / AIDS FOR DISABLED PEOPLE / AYUDAS PARA MINUSVÁLIDOS.

IN.12.009.D

IN.12.009.E

Barra de apoio de parede /
Wall safety support /
Barra de apoyo de pared.

MATERIAL: EN 1.4301 / AISI 304

STANDARD FINISH: SATINADO / SATIN / SATIN

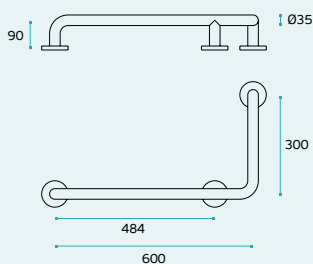

IN.12.009.D



IN.12.009.E

IN.12.010

IN.12.010.E

Barra de apoio de parede /
Wall safety support /
Barra de apoyo de pared.

MATERIAL: EN 1.431 / AISI 304

STANDARD FINISH: SATINADO / SATIN / SATIN

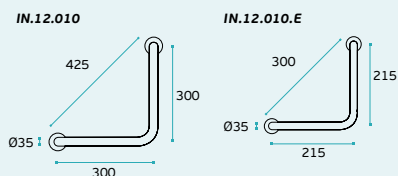

IN.12.010



IN.12.010.E

IN.12.011

Barra de apoio de parede /
Wall safety support /
Barra de apoyo de pared.

MATERIAL: EN 1.4301 / AISI 304

STANDARD FINISH: SATINADO / SATIN / SATIN

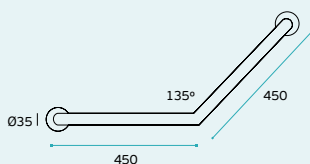

IN.12.015.D
IN.12.015.E
Barra de apoio de parede /
Wall safety support /
Barra de apoyo de pared.

MATERIAL: EN 1.4301 / AISI 304

STANDARD FINISH: SATINADO / SATIN / SATIN

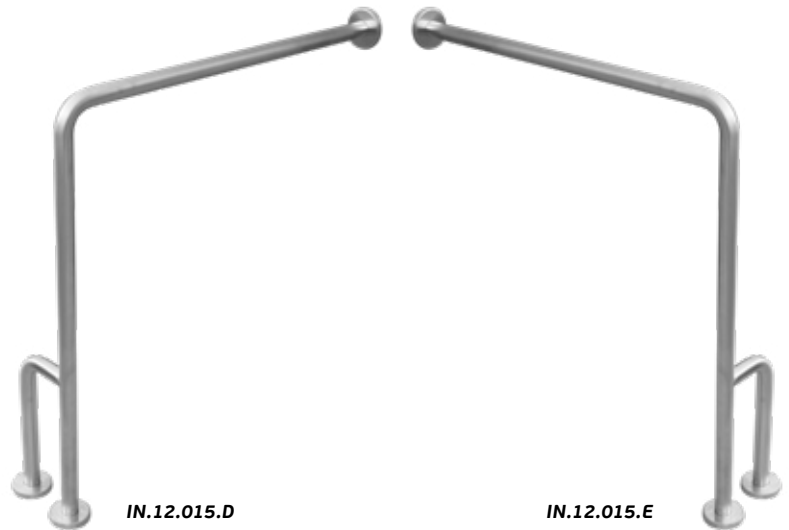
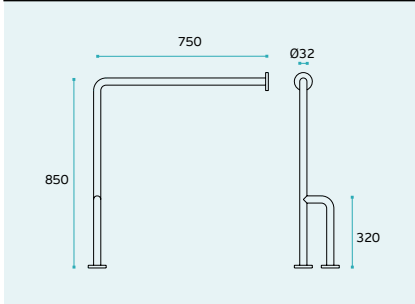

IN.12.029
Barra de apoio de parede /
Wall safety support /
Barra de apoyo de pared.

MATERIAL: EN 1.4301 / AISI 304

STANDARD FINISH: SATINADO / SATIN / SATIN

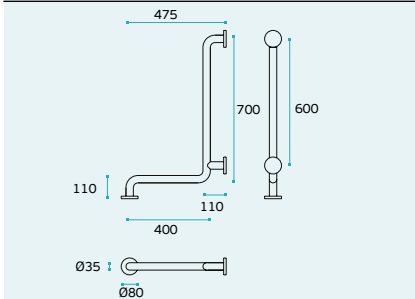

IN.12.025 / IN.12.026
IN.12.027 / IN.12.028
Barra de apoio de parede /
Wall safety support /
Barra de apoyo de pared.

MATERIAL: EN 1.4301 / AISI 304

STANDARD FINISH: SATINADO / SATIN / SATIN

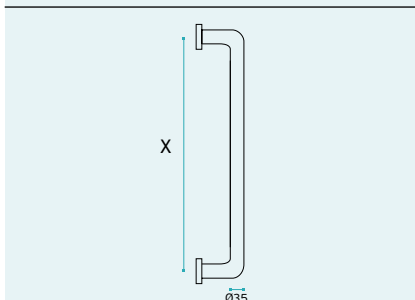

REF	X
IN.12.025	425mm
IN.12.026	600mm
IN.12.027	800mm
IN.12.028	1000mm

AUXÍLIOS PARA PESSOAS COM MOBILIDADE CONDICIONADA / AIDS FOR DISABLED PEOPLE / AYUDAS PARA MINUSVÁLIDOS.

A JNF dispõe de uma gama de acessórios de apoio a pessoas com mobilidade condicionada. Estes produtos encontram-se abrangidos pelo Decreto-Lei n.º 163/2006 de 8 de Agosto, o qual tem por objecto a definição das condições de acessibilidade a satisfazer no projecto e na construção de espaços públicos, edifícios públicos e habitacionais.

INFORMAÇÃO TÉCNICA:

Secção 4.11 – Corrimãos e barras de apoio

4.11.1 - Devem ter um diâmetro ou largura das superfícies de prensão compreendido entre 35 mm e 50 mm, ou ter uma forma que proporcione uma superfície de prensão equivalente.

4.11.4 – Não devem possuir superfícies abrasivas, extremidades projectadas perigosas ou arestas vivas.

4.11.6 – Devem possuir uma resistência mecânica adequada às solicitações previsíveis e devem ser fixos a superfícies rígidas e estáveis.

2.9.16 – Para além do especificado na secção 4.11, as barras de apoio instaladas junto dos aparelhos sanitários, devem satisfazer as seguintes condições:

1) Podem ter formas, dimensões, modos de fixação e localizações diferentes das definidas, se possuírem as superfícies de prensão nas localizações definidas ou ser comprovado que melhor se adequam às necessidades dos utentes.

2) Devem ter capacidade de suportar uma carga não inferior a 1,5 kN, aplicada em qualquer sentido.

Secção 2.9.4 – Ponto 5

Junto à sanita devem existir barras de apoio e, caso sejam adjacentes à zona livre, devem ser rebatíveis. Estas devem respeitar uma das seguintes condições:

JNF has a range of support accessories that meets the needs of disabled people. These products are aimed at defining the conditions for accessibility to meet the design and construction of public spaces, public buildings and housing.

TECHNICAL INFORMATION:

Section 4.11 – Handrails and Handlebars

4.11.1 - Must have a hold diameter or width standing between 35mm and 50mm, or have a shape that provides an equivalent surface.

4.11.4 – Must not have abrasive surfaces, dangerous projected ends or sharp edges.

4.11.6 – Must have an appropriate mechanical resistance to the predictable requests and must be fixed to stable and hard surfaces.

2.9.16 – Apart from that specified in Section 4.11, the support bars fitted with sanitary appliances, must meet the following conditions:

1) They may have shapes, sizes, fixation methods and locations different than those listed, if they have the areas of grip locations defined or proven to be best suited to the needs of users.

2) Shall be capable of withstanding a load of not less than 1.5 kN applied in any direction.

Section 2.9.4 – Point 5

Next to the toilet should be grab bars, and if they are adjacent to the free zone should be folding.

These must meet one of the following conditions:

JNF tiene una gama de accesorios de apoyo que satisfaga las necesidades de las personas con discapacidad. Estos productos tienen como objetivo definir las condiciones de accesibilidad para cumplir con el diseño y construcción de espacios públicos, edificios públicos y viviendas.

INFORMACIÓN TÉCNICA:

Secção 4.11 – Pasamanos y barras de apoyo

4.11.1 - Debe tener un diámetro o anchura de la superficie de agarre entre 35 mm y 50 mm, o tener una manera de proporcionar una superficie de agarre equivalente.

4.11.4 – No deben tener superficies abrasivas, bordes proyectados bordes afilados o peligrosos.

4.11.6 – Debe tener una resistencia mecánica adecuada a las demandas previsibles y debe fijarse en una superficie rígida y estable.

2.9.16 – Aparte de lo especificado en la sección 4.11, el apoyo bares equipados con aparatos sanitarios, deben cumplir las siguientes condiciones:

1) Pueden tener formas, tamaños, métodos de fijación y los lugares a los mencionados, si tienen las zonas de agarre de los lugares definidos o demostrado ser más adecuada a las necesidades de los usuarios.

2) Deberá ser capaz de soportar una carga no inferior a 1,5 kN aplicada en cualquier dirección.

Sección 2.9.4 – Punto 5

Junto a lo inodoro deben ser barras de apoyo, y si son adyacentes a la zona libre debe ser plegado. Estos deben cumplir con una de las siguientes condiciones:

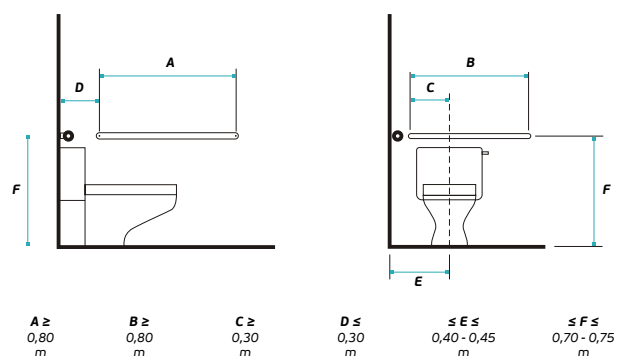
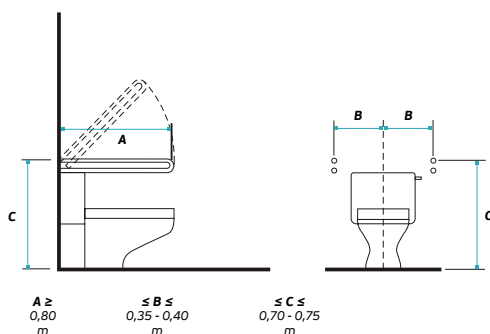

Secção 2.9.7 – Ponto 6
Junto à banheira devem existir barras de apoio nas localizações com as dimensões definidas em seguida para cada uma das posições do assento:

Sección 2.9.7 – Point 6
Next to the bath should be grab bars and the dimensions defined below for each of the positions of the seat:

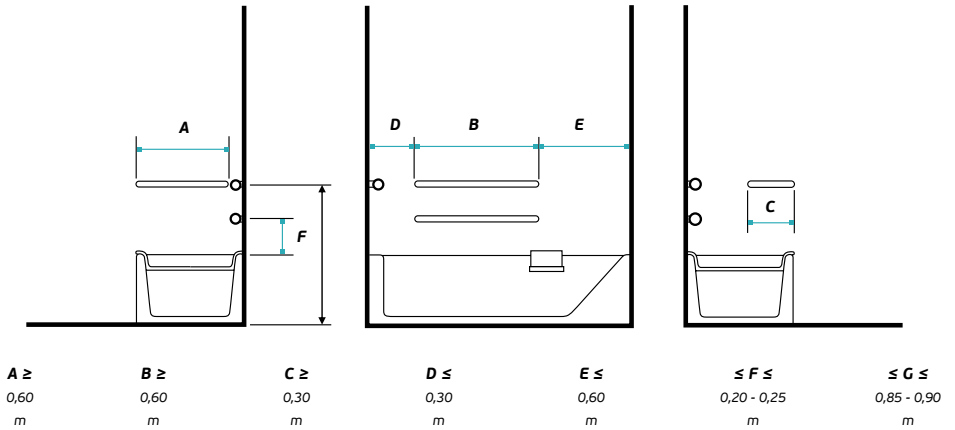

Sección 2.9.7 – Punto 6
Junto al baño deben ser barras de apoyo y las dimensiones se definen a continuación para cada una de las posiciones del asiento:

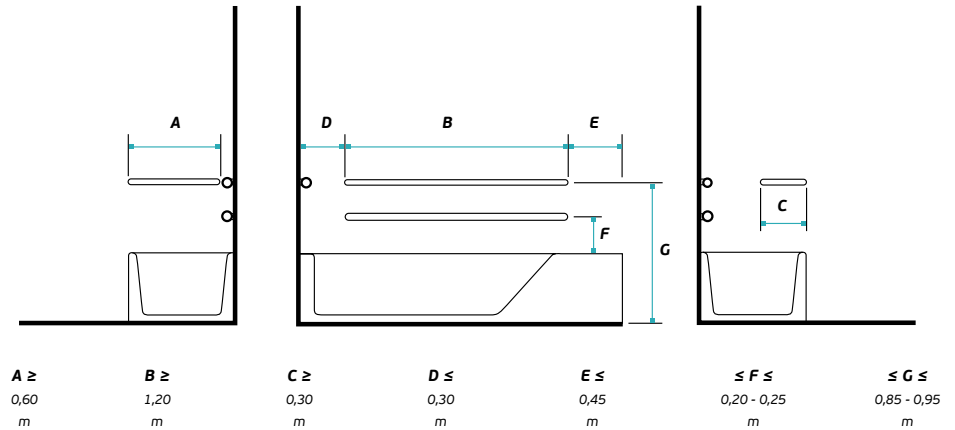

Secção 2.9.10 – Ponto 6
Junto à base de duche devem ser instaladas barras de apoio de acordo com o definido:

Sección 2.9.10 – Point 6
Next to the shower must be installed grab bars in accordance with the defined:

Sección 2.9.7 – Punto 6
Junto al baño deben ser barras de apoyo y las dimensiones se definen a continuación para cada una de las posiciones del asiento:

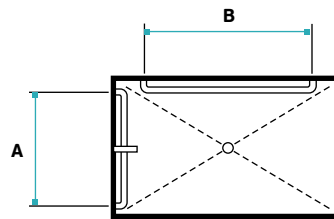

Secção 2.9.12 – Ponto 4
Junto aos urinóis devem existir barras verticais de apoio, fixadas com um afastamento de 0,3m do eixo do urinol a uma altura do piso de 0,75m e com um comprimento não inferior a 0,7m.

Sección 2.9.12 – Point 4
Along the urinals shall be of vertical bars of support, set with a spacing of 0,3m from the axis of the urinal to a floor height of 0,75m and a length not less than 0,7m.

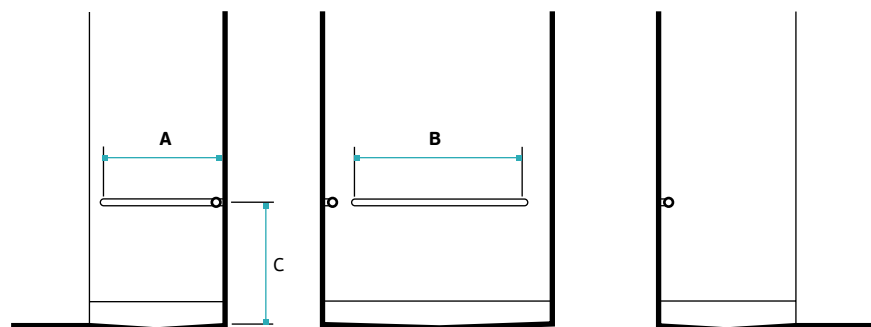

$A \geq$	$B \geq$	$\leq C \leq$
0,70	1,00	0,85 - 0,95
m	m	m

Sección 2.9.12 – Punto 4
A lo largo de los urinarios deben ser de barras verticales de apoyo, creado con una separación de 0,3m del eje del urinario a una altura del suelo de 0,75m y una longitud no inferior a 0,7m.

BIN SERIES

ACESSÓRIOS PARA CASA DE BANHO /
BATHROOM ACCESSORIES /
ACCESORIOS DE BAÑO.



.P
Mirror
finish

.TB
PVD
Titanium
black

.TG
PVD
Titanium
gold

.TCO
PVD
Titanium
copper

.TCH
PVD
Titanium
chocolate



FECHO SILENCIOSO

Com o objectivo de criar um fecho silencioso, foi instalado um amortecedor na tampa assegurando um fecho muito lento e suave /

SILENT CLOSE

In order to make it quiet we instal a shock absorber in the lid ensuring a very soft and smooth closing /

CIERRE SILENCIOSO

Con el objetivo de crear un cierre silencioso se ha instalado un amortiguador que garantiza un cierre muy lento y suave.



BALDE INTERNO AMOVÍVEL

Balde interior plástico amovível com pega. Material impermeável, permite receber líquidos e ser facilmente lavável /

REMOVABLE INNER BUCKET

Durable inner bucket catches messy drips and lifts out for easy cleaning /

INTERIOR DE LA PAPELERA DESMONTABLE

Plástico interior de la papelera extraíble con tirador, material impermeable, le permite recibir líquidos y fácilmente lavable.



PEDAL

Normalmente, o pedal do balde é a primeira peça a sofrer desgaste, desta forma foi reforçada com o intuito de torná-la mais resistente. Foi testado mais de 100.000 ciclos /

PEDAL

Usually the pedal of the step is the first thing to be broken, that is why we reinforce it and make it really strong. We test it over 100.000 cycles /

PEDAL:

Típicamente, el pedal del cubo es la primera parte a sufrir daños, es por lo tanto reforzada con el fin de hacerla más resistente. Más de 100.000 ciclos de prueba.



ANTI MARCAS DE DEDOS

Acabamento à prova de impressões digitais, resiste a manchas mantendo o aço inoxidável brilhante /

FINGERPRINT-PROOF

Fingerprint-proof finish resists smudges to keep stainless steel shiny /

A PRUEBA DA HUELLA DIGITALES

Acabado anti-huellas resiste manchas manteniendo el acero inoxidable brillante.

BIN SERIES

ACESSÓRIOS PARA CASA DE BANHO /
 BATHROOM ACCESSORIES /
 ACCESORIOS DE BAÑO.

NEW

IN.65.203.05

Balde /
 Bin / Balde

MATERIAL: EN 1.4301 / AISI 304

ACABAMENTO / FINISH / ACABADO:
 STANDARD: SATINADO / SATIN / SATIN

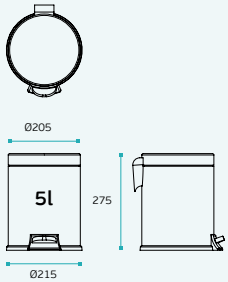

NEW

IN.65.203.05.TB

Balde /
 Bin / Balde

.TB

MATERIAL: EN 1.4301 / AISI 304

ACABAMENTO / FINISH / ACABADO:
 TITANIUM BLACK

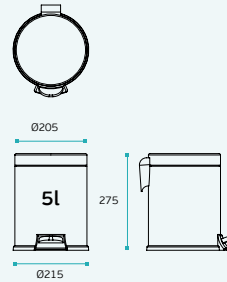

.P
 Mirror
 finish

.TB
 PVD
 Titanium
 black

.TG
 PVD
 Titanium
 gold

.TCO
 PVD
 Titanium
 copper

.TCH
 PVD
 Titanium
 chocolate

NEW

IN.65.203.05.TG

Balde /
 Bin / Balde

.TG

MATERIAL: EN 1.4301 / AISI 304

ACABAMENTO / FINISH / ACABADO:
 TITANIUM GOLD

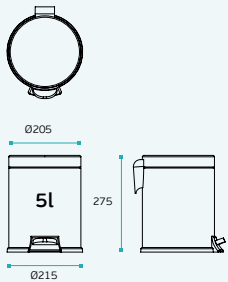

NEW

IN.65.203.05.TCO

Balde /
 Bin / Balde

.TCO

MATERIAL: EN 1.4301 / AISI 304

ACABAMENTO / FINISH / ACABADO:
 TITANIUM COPPER

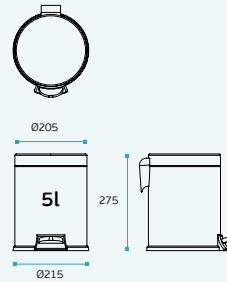

NEW

IN.65.203.05.TCH

Balde /
 Bin / Balde

.TCH

MATERIAL: EN 1.4301 / AISI 304

ACABAMENTO / FINISH / ACABADO:
 TITANIUM CHOCOLATE

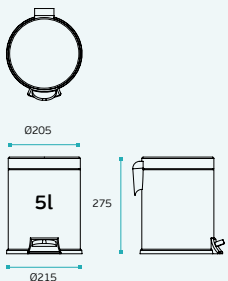

NEW

IN.65.203.05.B

Balde /
 Bin / Balde

.B

ACABAMENTO / FINISH / ACABADO:
 RAL 9005

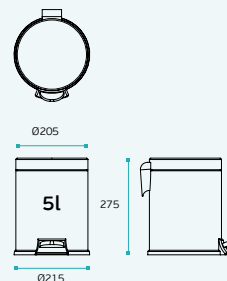

.P
Mirror
finish

.TB
PVD
Titanium
black

.TG
PVD
Titanium
gold

.TCO
PVD
Titanium
copper

.TCH
PVD
Titanium
chocolate

IN.65.203.30

Balde /
Bin / Balde

MATERIAL: EN 1.4301 / AISI 304

ACABAMENTO / FINISH / ACABADO:
STANDARD: SATINADO / SATIN / SATIN

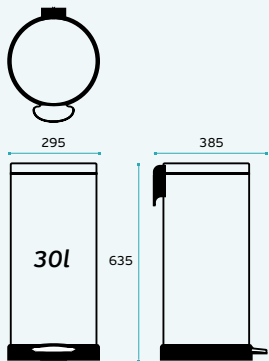

IN.65.203.20

Balde /
Bin / Balde

MATERIAL: EN 1.4301 / AISI 304

ACABAMENTO / FINISH / ACABADO:
STANDARD: SATINADO / SATIN / SATIN

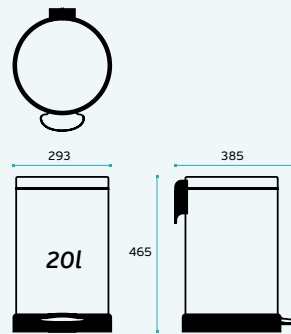

IN.65.203.12

Balde /
Bin / Balde

MATERIAL: EN 1.4301 / AISI 304

ACABAMENTO / FINISH / ACABADO:
STANDARD: SATINADO / SATIN / SATIN

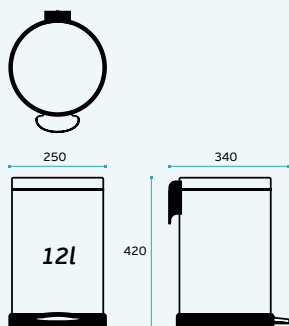

IN.65.182

Balde /
Bin / Balde

MATERIAL: EN 1.4301 / AISI 304

ACABAMENTO / FINISH / ACABADO:
STANDARD: SATINADO / SATIN / SATIN

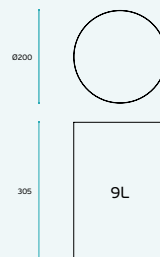

BIN SERIES

ACESSÓRIOS PARA CASA DE BANHO /
 BATHROOM ACCESSORIES /
 ACCESORIOS DE BAÑO.

IN.65.201.30

Balde /
 Bin / Balde

MATERIAL: EN 1.4301 / AISI 304

ACABAMENTO / FINISH / ACABADO:
STANDARD: SATINADO / SATIN / SATIN

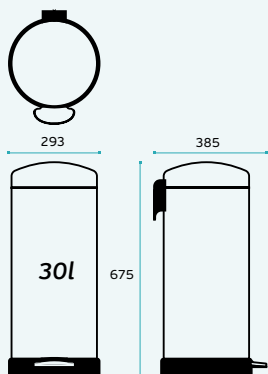

IN.65.201.20

Balde /
 Bin / Balde

MATERIAL: EN 1.4301 / AISI 304

ACABAMENTO / FINISH / ACABADO:
STANDARD: SATINADO / SATIN / SATIN

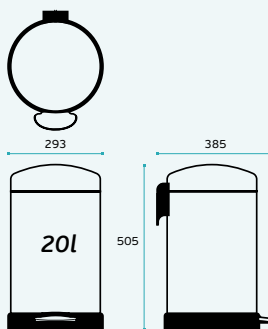

IN.65.201.12

Balde /
 Bin / Balde

MATERIAL: EN 1.4301 / AISI 304

ACABAMENTO / FINISH / ACABADO:
STANDARD: SATINADO / SATIN / SATIN

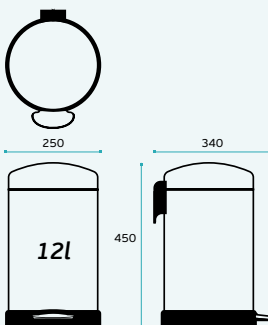

IN.65.201.03

Balde /
 Bin / Balde

MATERIAL: EN 1.4301 / AISI 304

ACABAMENTO / FINISH / ACABADO:
STANDARD: SATINADO / SATIN / SATIN

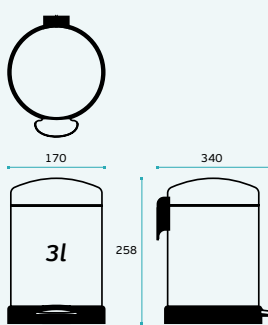



IN.65.202

Balde / Bin / Balde



IN.65.202.PA
Balde reciclagem /
Recycling bin /
Papelera reciclaje.



IN.65.202.GE
Balde reciclagem /
Recycling bin /
Papelera reciclaje.



IN.65.202.GL
Balde reciclagem /
Recycling bin /
Papelera reciclaje.



IN.65.202.PL
Balde reciclagem /
Recycling bin /
Papelera reciclaje.



MATERIAL: EN 1.4301 / AISI 304

ACABAMENTO / FINISH / ACABADO:
STANDARD: SATINADO / SATIN / SATIN

